



---

# Durox Locomotive Products Catalog

---

Durox Company  
12312 Alameda Drive  
Strongsville, OH 44149



AAR M-1003, ISO 9001:2008



[www.durox.com](http://www.durox.com)



800.238.5360



## TABLE OF CONTENTS:

Table of Contents	1
About Durox	2
Swellex™ Gasket Material	3
Exhaust Manifold Gaskets	5
High Performance Fluoroelastomers	6
Pipe Coupling Gasket Seals	7
- “M” Style	7
- “V” Style	8
- “D” Style	9
Traction Motor Covers & Gaskets	12
Cleats & Grommets	14
Pressure Gauges	15
Other Engine Parts	17
- Fuel Line	17
- Lube Oil Line	17
- Piston Cooling Tube	17
- Cylinder Head Seat Ring	18
- Water Discharge Elbows & O’Ring Seals	18
- Sand Nozzles	18
- Brake Handles	19
Durox Enhanced Products	20
- Vector® & Corners	20
- Layshaft Seal w/ Oil Deflector Sleeve	20
- Fuel Site Bowl Clevis & Seal Kit	21
- Governor Plug Protector	21
- Plastic Covers	22
- Magnetic Signs	23
Locomotive Gasket & Seal Overhaul Kits	24
- EMD Kits	25
- EMD Kit BOMs	35

# ABOUT DUROX

---

Durox is a “one stop shop” providing a complete line of high performance products designed to maximize the life cycles of engines and component parts. Durox designs and manufactures a range of gaskets, rubber seals, extrusions and other related components with a focus on railway and industrial market applications.

## Product Examples:

- Die Cut Gaskets: Locomotive Gaskets, Exhaust Gaskets, Traction Motor Gaskets
- Molded Rubber Products: Pipe Coupling Gaskets & Seals; Cable & Pipe Cleats
- Spliced Rubber Seals: Corner Molded Door & Window Seals, Spiced O’Rings
- Extrusions: Door Seals, Window Glazing, Number Boards
- OEM & Customer Specific Gasket & Seal Overhaul Kits

## Quality Certifications:

- AAR M-1003
- ISO 9001:2008



**Die Cutting**  
(ATOM Flashcut Flex)



**Custom Extrusion**  
(Continuous Salt Line & Microwave Curing)



**Custom Rubber Molding**  
(Compression & Transfer Molding Presses)



**Custom Compound Mixing**  
(Complete In-House Mixing Capabilities)

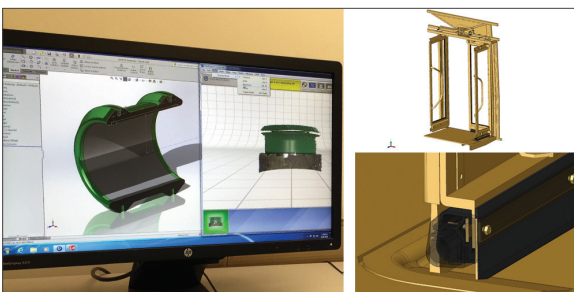

**Design & Development Engineering Support**  
(From Concept & Design, to Prototype & Production)



**Testing & Validation**  
(Comprehensive Materials Lab & Test Equipment)

# SWELLEX™ GASKET MATERIAL

---

Swellex™ is a Durox proprietary controlled swell compressed sheet gasket material that creates its own load when it comes into contact with oil or water. This controlled swell provides superior conformation to irregular surfaces created by worn flange surfaces. Because the material does not degrade in contact with oil or water, it is an ideal gasket material for a wide range of applications.

## Benefits:

- The unique blend of synthetic fibers with custom blend rubber binders creates comprehensive load in light weight flanges in oil and water.
- The load created by our proprietary controlled swell provides and retains superior torque retention.
- More compressible than standard fiber gaskets and seals with lower flange loading.
- Because its crush strength is many times higher than a rubber gasket, it provides excellent sealing in applications that would crush traditional rubber seals.
- The compressed material does not wick or weep system fluids which helps to optimize overall machinery performance and improves plant safety.

## Values:

- Reduce Inventory: The variety of elastomers in the blend excel in a wide range of services and replace those products that only swell in oil.
- Minimize Costs & Maintenance Time: Swellex™ seals worn surfaces on flanges that would traditionally be replaced more frequently.
- Quicker Installation Time: Eliminates the need to use additional sealants on gasket or flange surfaces.
- Reduce Labor & Overtime: The flange free release coating on the gasket insures fast and easy removal of the product.

## Ideal For:

- |                 |                    |
|-----------------|--------------------|
| • Compressors   | • Fuel Pumps       |
| • Fuel Pumps    | • Cast Flanges     |
| • Oil Pumps     | • Lube Oil Systems |
| • Water Pumps   | • Radiators        |
| • Access Covers | • Water Systems    |
| • Generators    | • Fuel Systems     |

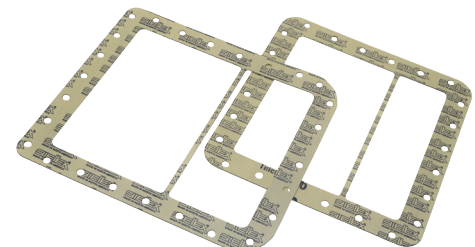

## Available in the Following Thicknesses:

1/64"    1/32"    3/64"    1/16"    3/32"    1/8"

# SWELLEX™ GASKET MATERIAL

## SWELLEX™ Percent Swell (%) in Oil @ 300°F

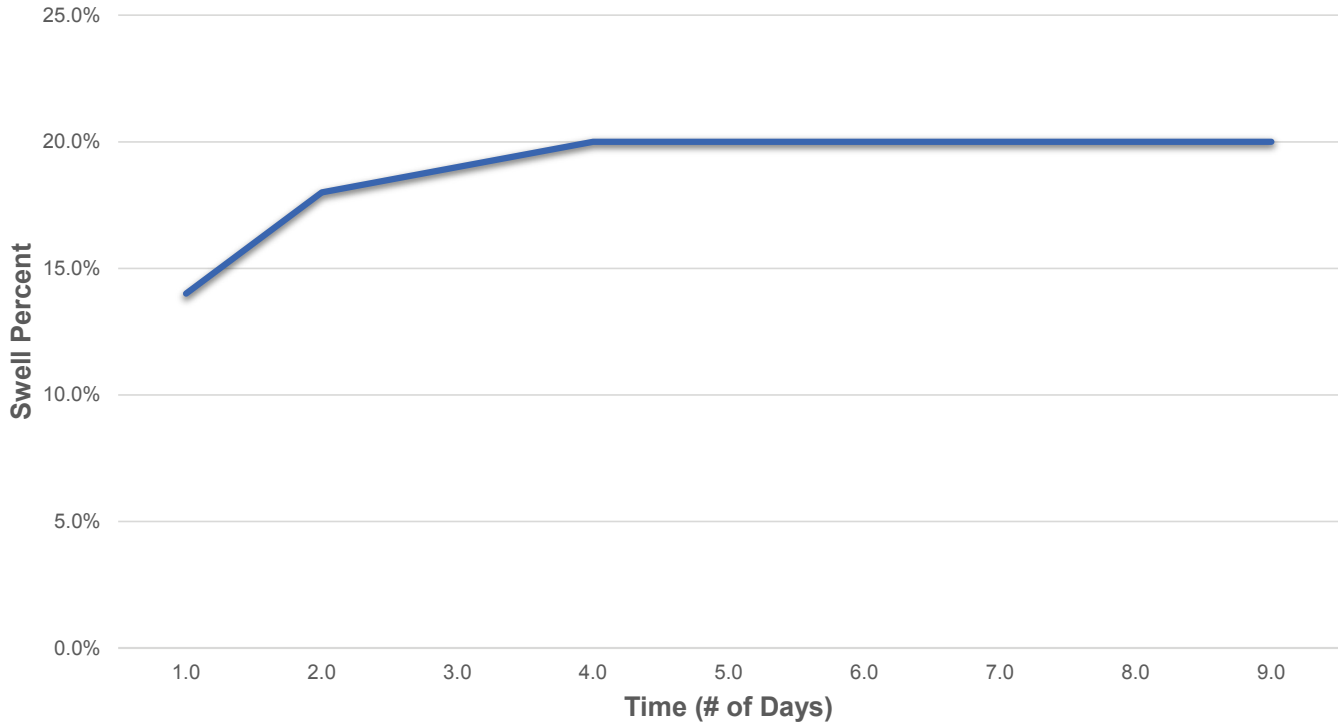

## Durox Gasket Load - SWELLEX™ vs Competition (Submerged in Oil @300°F Starting at 20 lbs load)

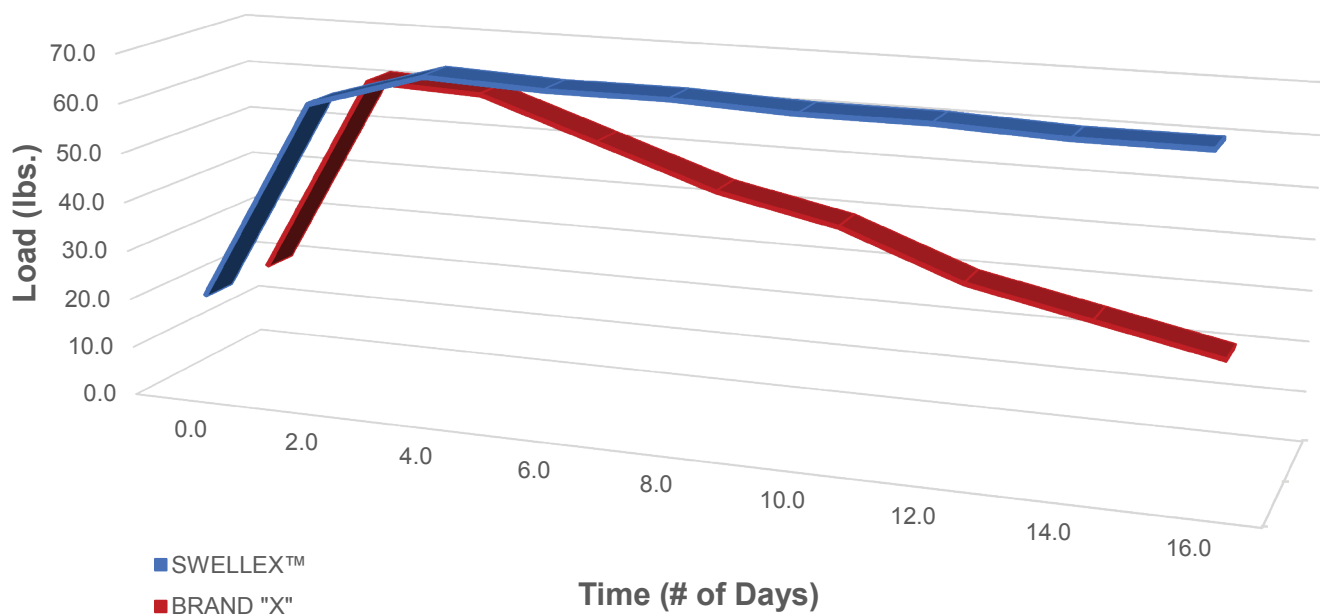

# EXHAUST MANIFOLD GASKETS

Durox's High Performance Engine Exhaust Gasket System helps to protect locomotive exhaust systems throughout the entire life cycle.

- Preferred by Class I railroads, our high performance chamber to crankcase gasket features a metal jacketed design to aid in protecting the engine crankcase and exhaust manifolds.
- Durox High Performance Exhaust Gaskets utilize an inner graphite core that works effortlessly in extreme temperatures created by the exhaust system.
- When the complete Durox High Performance Exhaust Gasket system is applied, the inner graphite core remains intact throughout the entire life of the exhaust system to ensure proper torque loading and eliminates leaks.

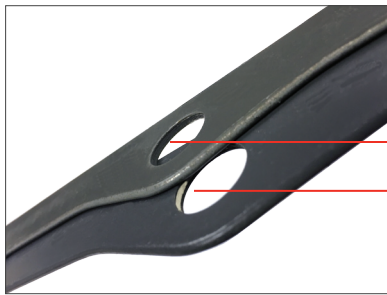
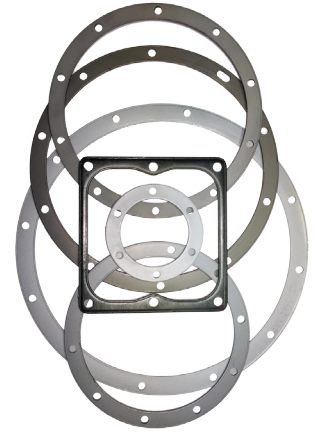

Durox Dark High Performance Graphite

OEM Standard White High Temperature Gasket Material

## Exhaust Manifold Application

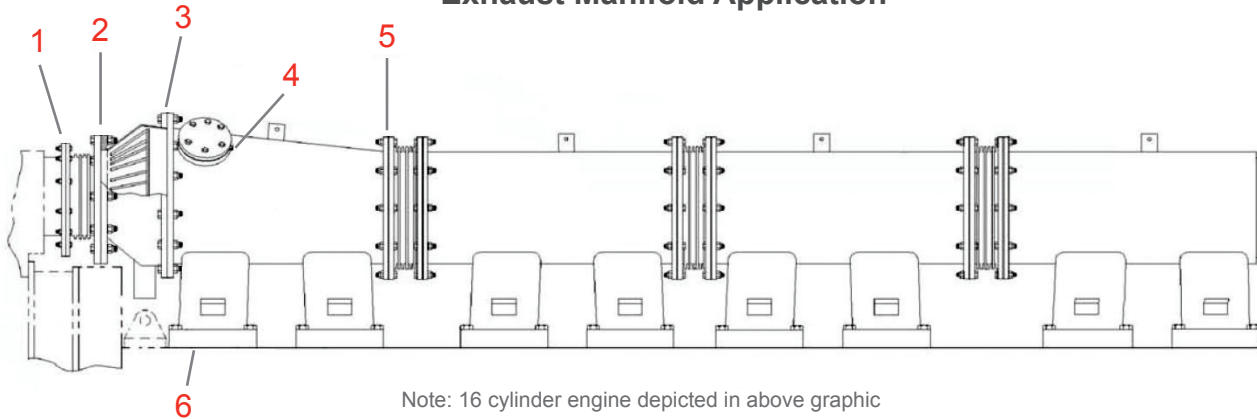

Ref #	OEM #	Durox #	Description	8 Cyl.	12 Cyl.	16 Cyl.	20 Cyl.
1	40026939	DE14154	GASKET: Expansion joint to turbocharger (replaces 9572292)	2	4	6	8
2	40026938	DE14156	GASKET: Adapter to expansion joint (replaces 9570093)	1	1	1	1
3	40026936	DE14158	GASKET: Chamber to adapter (replaces 9572295)	1	1	1	1
4	9571663	DE14159	GASKET: Cover flange to manifold flange	1	1	1	1
5	40026937	DE14157	GASKET: Expansion joint to chamber (replaces 9572294)	1	1	1	1
6	40055466	DE14155	GASKET: Chamber to crankcase - exhaust manifold leg (replaces 9571655 & 40034378)	4	6	8	10

# HIGH PERFORMANCE FLUOROELASTOMER SEALS

Traditionally, most seals in a locomotive engine are made of Nitrile rubber. While a new Nitrile seal is soft and flexible at temperatures of around 150°F to 180°F, the elastomer that makes the seal flexible starts to bake out of the product. These temperatures are produced by the locomotive engine in normal operation and the result is a hard, cracked rubber product that no longer effectively seals.

Durox has replaced all these traditional seals with High Performance Fluoroelastomer Seals. Fluoroelastomer is a rubber compound that remains soft and flexible at temperatures up to 480°F, a temperature range that the locomotive engine does not produce in normal operation.

Durox green Fluoroelastomer Seals are made in various custom formulations that are designed for specific end-use applications including formulations for pipe coupling gaskets and O-rings.

- The Fluoroelastomer formulation for the “M” type seal is designed with a very high modulus so that the part will resist creep and deformation once it is installed.
- The Fluoroelastomer formulation for the “V” style seal application is designed to have a high resistance to tearing and flex cracking.
- These special formulations are optimized so that the product meets the requirements of the specific application in addition to having outstanding performance in high temperatures and resistance to fuel, oil, water and additives used in the maintenance of locomotive engines.

**Durox - Seal Test  
Compression Set Test @ 22 Hours**

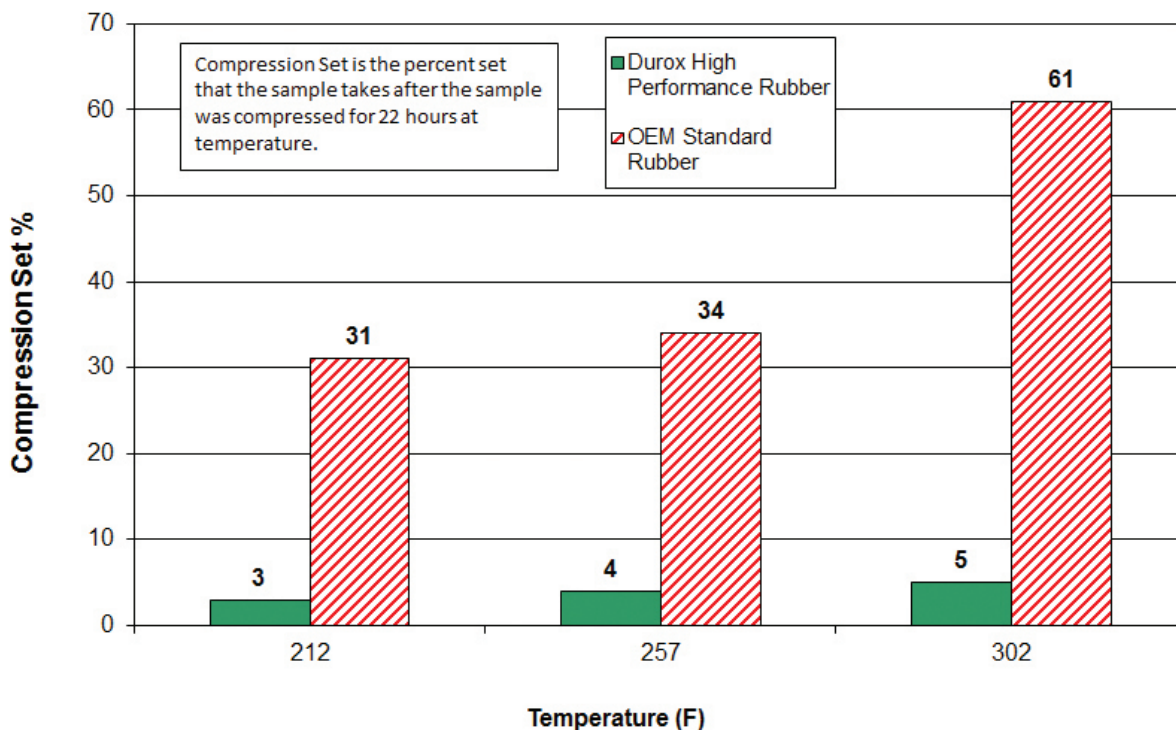

# PIPE COUPLING GASKETS

## “M” Style Seals



OEM #	Durox #	Pipe ID	Seal ID	Type	Material	Description
<b>“M” Style</b>						
8479542HT	DE1072	0.50"	0.88"	H	Fluoroelastomer	1/2" Seal, Hi-Temp
8479542	DE10137	0.50"	0.88"	S	Nitrile	1/2" Seal
8479543HT	DE10155	0.75"	1.00"	H	Fluoroelastomer	3/4" Seal, Hi-Temp
16391378HT	DE4429	0.75"	1.00"	H	Fluoroelastomer	3/4" Seal, Hi-Temp
8479543	DE10070	0.75"	1.00"	S	Nitrile	3/4" Seal
8479544HT	DE10156	1.00"	1.25"	H	Fluoroelastomer	1" Seal, Hi-Temp
8479544HT	DE10142	1.00"	1.25"	S	Nitrile	1" Seal
8479598HT	DE10183	1.25"	1.63"	H	Fluoroelastomer	1 1/4" Seal, Hi-Temp
41A242065P2HT	DE50084	1.25"	1.63"	H	Fluoroelastomer	1 1/4" Seal, Hi-Temp
8479598	DE10376	1.25"	1.63"	S	Nitrile	1 1/4" Seal
41A242065P2	DE50094	1.25"	1.63"	S	Nitrile	1 1/4" Seal
8479599HT	DE10185	1.50"	1.90"	H	Fluoroelastomer	1 1/2" Seal, Hi-Temp
8479599	DE10144	1.50"	1.90"	S	Nitrile	1 1/2" Seal
8479600HT	DE10184	2.00"	2.38"	H	Fluoroelastomer	2" Seal, Hi-Temp
8479600	DE10143	2.00"	2.38"	S	Nitrile	2" Seal
41A242065P3HT	DE50080	2.00"	2.38"	H	Fluoroelastomer	2" Seal, Hi-Temp
41A242065P3	DE50019	2.00"	2.38"	S	Nitrile	2" Seal
8479601HT	DE10163	2.50"	3.00"	H	Fluoroelastomer	2 1/2" Seal, Hi-Temp
8479601	DE2006	2.50"	3.00"	S	Nitrile	2 1/2" Seal
8479602HT	DE10157	3.00"	3.50"	H	Fluoroelastomer	3" Seal, Hi-Temp
8479602	DE2007	3.00"	3.50"	S	Nitrile	3" Seal
41A242065P4HT	DE50081	3.00"	3.50"	H	Fluoroelastomer	3" Seal, Hi-Temp
41A242065P4	DE50021	3.00"	3.50"	S	Nitrile	3" Seal
8479603HT	DE10158	3.50"	4.00"	H	Fluoroelastomer	3 1/2" Seal, Hi-Temp
8479603	DE10028	3.50"	4.00"	S	Nitrile	3 1/2" Seal
41A242065P1HT	DE50079	3.50"	4.00"	H	Fluoroelastomer	3 1/2" Seal, Hi-Temp
41A242065P1	DE50022	3.50"	4.00"	S	Nitrile	3 1/2" Seal
8479604HT	DE10159	4.00"	4.50"	H	Fluoroelastomer	4" Seal, Hi-Temp
8479604	DE2008	4.00"	4.50"	S	Nitrile	4" Seal
41A242065P5HT	DE50082	4.00"	4.50"	H	Fluoroelastomer	4" Seal, Hi-Temp
41A242065P5	DE50018	4.00"	4.50"	S	Nitrile	4" Seal
40138075	DE11544	5.00"	5.50"	S	Fluoroelastomer	5" Seal, Hi-Temp
8406231HT	DE11585	6.00"	6.50"	H	Fluoroelastomer	6" Seal, Hi-Temp
8406231	DE11603	6.00"	6.50"	S	Nitrile	6" Seal
41A242065P6HT	DE51202	6.00"	6.50"	H	Fluoroelastomer	6" Seal, Hi-Temp
41A242065P6	DE51201	6.00"	6.50"	S	Nitrile	6" Seal



# PIPE COUPLING GASKETS

## “V” Style Seals



OEM #	Durox #	Pipe ID	Seal ID	Type	Material	Description
<b>“V” Style 75</b>						
41C624988P105HT	DE53020	2.00"	2.00"	H	Fluoroelastomer	2" Seal, Hi-Temp
41C624988P106HT	DE32080	2.50"	2.50"	H	Fluoroelastomer	2 1/2" Seal, Hi-Temp
41C624988P107HT	DE52728	3.00"	3.00"	H	Fluoroelastomer	3" Seal, Hi-Temp
41C624988P8	DE50133	3.50"	3.50"	S	Fluoroelastomer	3 1/2" Seal, Hi-Temp
41C624988P109	DE50134	4.00"	4.00"	S	EPDM	4" Seal
41C624988P109HT	DE50137	4.00"	4.00"	H	Fluoroelastomer	4" Seal, Hi-Temp
41C624988P110	DE50135	5.00"	5.00"	S	EPDM	5" Seal
41C624988P110HT	DE50138	5.00"	5.00"	H	Fluoroelastomer	5" Seal, Hi-Temp
41C624988P111	DE50136	6.00"	6.00"	S	EPDM	6" Seal
41C624988P111HT	DE50181	6.00"	6.00"	H	Fluoroelastomer	6" Seal, Hi-Temp
41C624988P212HT	DE33088	8.00"	8.00"	H	Fluoroelastomer	8" Seal, Hi-Temp

## “V” Style Reducers

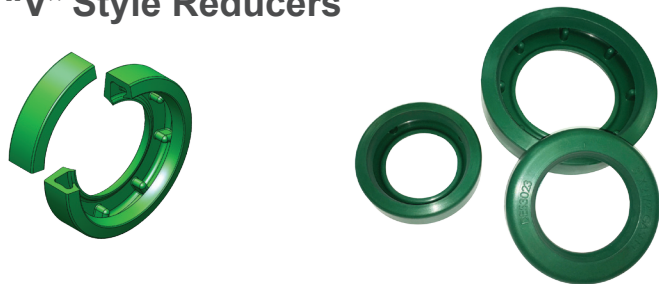

OEM #	Durox #	Pipe ID	Seal ID	Type	Material	Description
<b>“V” Style Reducers</b>						
84B107007P1HT	DE53024	2.50" - 2.00"	2.50" - 2.00"	H	Fluoroelastomer	2 1/2" - 2" Seal, Hi-Temp
41B548215APP1HT	DE53023	3.00" - 2.50"	3.00" - 2.50"	H	Fluoroelastomer	3" - 2 1/2" Seal, Hi-Temp
41B548215APP2HT	DE53021	4.00" - 3.00"	4.00" - 3.00"	H	Fluoroelastomer	4" - 3" Seal, Hi-Temp

# PIPE COUPLING GASKETS

## “D” Style Seals



OEM #	Durox #	Pipe ID	Seal ID	Type	Material	Description
<b>“D” Style 38</b>						
499A912AEP3	DE5563	0.75"	1.00"	H	Fluoroelastomer	3/4" Seal, Hi-Temp
115X2603	DE5563	0.75"	1.00"	H	Fluoroelastomer	3/4" Seal, Hi-Temp
499A912AEP4	DE50072	1.00"	1.31"	H	Fluoroelastomer	1" Seal, Hi-Temp
41A213752P4	DE50072	1.00"	1.31"	H	Fluoroelastomer	1" Seal, Hi-Temp
115X2604	DE50072	1.00"	1.31"	H	Fluoroelastomer	1" Seal, Hi-Temp
499A912ADP3	DE5455	1.25"	1.63"	H	Fluoroelastomer	1 1/4" Seal, Hi-Temp
499A912AEP5	DE5455	1.25"	1.63"	H	Fluoroelastomer	1 1/4" Seal, Hi-Temp
115X2462	DE5455	1.25"	1.63"	H	Fluoroelastomer	1 1/4" Seal, Hi-Temp
115X2605-1	DE5455	1.25"	1.63"	H	Fluoroelastomer	1 1/4" Seal, Hi-Temp
41A213752P5	DE5454	1.25"	1.63"	S	Nitrile	1 1/4" Seal
115X2605-1	DE50045	1.25"	1.63"	S	EPDM	1 1/4" Seal
499A912AEP6	DE5564	1.50"	2.00"	H	Fluoroelastomer	1 1/2" Seal, Hi-Temp
115X2606	DE5564	1.50"	2.00"	H	Fluoroelastomer	1 1/2" Seal, Hi-Temp
41A213752P6	DE5564	1.50"	2.00"	H	Fluoroelastomer	1 1/2" Seal, Hi-Temp
499A912AEP7	DE5439	2.00"	2.44"	H	Fluoroelastomer	2" Seal, Hi-Temp
115X2607	DE5439	2.00"	2.44"	H	Fluoroelastomer	2" Seal, Hi-Temp
115X2607-1	DE5439	2.00"	2.44"	H	Fluoroelastomer	2" Seal, Hi-Temp
41A221977P1	DE5439	2.00"	2.44"	H	Fluoroelastomer	2" Seal, Hi-Temp
115X2607-1	DE51200	2.00"	2.44"	S	EPDM	2" Seal
499A912AEP8	DE5311	2.50"	3.00"	S	Nitrile	2 1/2" Seal
16391328	DE4368	2.50"	3.00"	S	Nitrile	2 1/2" Seal
499A912AEP8	DE50073	2.50"	3.00"	H	Fluoroelastomer	2 1/2" Seal, Hi-Temp
115X2608	DE50073	2.50"	3.00"	H	Fluoroelastomer	2 1/2" Seal, Hi-Temp
8390925	DE11296	2.50"	3.00"	H	Fluoroelastomer	2 1/2" Seal, Hi-Temp
16391328	DE4408	2.50"	3.00"	H	Fluoroelastomer	2 1/2" Seal, Hi-Temp
8340702	DE10090	3.00"	3.50"	S	Nitrile	3" Seal
16391336	DE4367	3.00"	3.50"	S	Nitrile	3" Seal
499A912AEP9	DE5440	3.00"	3.50"	H	Fluoroelastomer	3" Seal, Hi-Temp
115X2560	DE5440	3.00"	3.50"	H	Fluoroelastomer	3" Seal, Hi-Temp
115X2609	DE5440	3.00"	3.50"	H	Fluoroelastomer	3" Seal, Hi-Temp
41A213752P9	DE5440	3.00"	3.50"	H	Fluoroelastomer	3" Seal, Hi-Temp
8340702	DE11297	3.00"	3.50"	H	Fluoroelastomer	3" Seal, Hi-Temp
16391336	DE4409	3.00"	3.50"	B	Fluoroelastomer	3" Seal, Hi-Temp

# PIPE COUPLING GASKETS

## “D” Style Seals (continued)



OEM #	Durox #	Pipe ID	Seal ID	Type	Material	Description
<b>“D” Style 38 (continued)</b>						
41A213752P9	DE5501	3.00"	3.50"	S	Nitrile	3" Seal
3038-0025-001	DE50049	3.00"	3.50"	S	EPDM	3" Seal
115X2560	DE50049	3.00"	3.50"	S	EPDM	3" Seal
3038-0032-001	DE5566	3.50"	4.00"	H	Fluoroelastomer	3 1/2" Seal, Hi-Temp
499A912AEP10	DE5566	3.50"	4.00"	H	Fluoroelastomer	3 1/2" Seal, Hi-Temp
115X2610	DE5566	3.50"	4.00"	H	Fluoroelastomer	3 1/2" Seal, Hi-Temp
499A912AEP11	DE5309	4.00"	4.50"	S	Nitrile	4" Seal
115X2611	DE5309	4.00"	4.50"	S	Nitrile	4" Seal
8372513	DE10091	4.00"	4.50"	S	Nitrile	4" Seal
3038-0035-001	DE5565	4.00"	4.50"	H	Fluoroelastomer	4" Seal, Hi-Temp
499A912AEP11	DE5565	4.00"	4.50"	H	Fluoroelastomer	4" Seal, Hi-Temp
115X2611	DE5565	4.00"	4.50"	H	Fluoroelastomer	4" Seal, Hi-Temp
41A213752P11	DE5565	4.00"	4.50"	H	Fluoroelastomer	4" Seal, Hi-Temp
8372513	DE11298	4.00"	4.50"	H	Fluoroelastomer	4" Seal, Hi-Temp
3038-0047-001	DE5464	5.00"	5.50"	H	Fluoroelastomer	5" Seal, Hi-Temp
499A912AEP12	DE5464	5.00"	5.50"	H	Fluoroelastomer	5" Seal, Hi-Temp
115X2561	DE5464	5.00"	5.50"	H	Fluoroelastomer	5" Seal, Hi-Temp
115X2612	DE5464	5.00"	5.50"	H	Fluoroelastomer	5" Seal, Hi-Temp
16391355	DE4417	5.00"	5.50"	H	Fluoroelastomer	5" Seal, Hi-Temp
3038-0047-001	DE5453	5.00"	5.50"	S	Nitrile	5" Seal
115X2612	DE5453	5.00"	5.50"	S	Nitrile	5" Seal
41A213752P12	DE5453	5.00"	5.50"	S	Nitrile	5" Seal
3038-0056-001	DE5567	6.00"	6.50"	H	Fluoroelastomer	6" Seal, Hi-Temp
499A912AEP13	DE5567	6.00"	6.50"	H	Fluoroelastomer	6" Seal, Hi-Temp
115X2613	DE5567	6.00"	6.50"	H	Fluoroelastomer	6" Seal, Hi-Temp
499A912AEP15	DE50074	8.00"	8.50"	H	Fluoroelastomer	8" Seal, Hi-Temp

# PIPE COUPLING GASKETS

## “D” Style Seals (continued)



OEM #	Durox #	Pipe ID	Seal ID	Type	Material	Description
<b>“D” Style 65</b>						
3065-0003-001	DE50077	0.75"	1.00"	H	Fluoroelastomer	3/4" Seal, Hi-Temp
8260913	DE10083	0.75"	1.00"	S	Nitrile	3/4" Seal
8260913HT	DE11300	0.75"	1.00"	H	Fluoroelastomer	3/4" Seal, Hi-Temp
499A912AFP4	DE5305	1.00"	1.31"	S	Nitrile	1" Seal
8260914	DE11302	1.00"	1.31"	S	Nitrile	1" Seal
16391340-2	DE4399	1.00"	1.31"	S	Nitrile	1" Seal
499A912AFP4HT	DE51145	1.00"	1.31"	H	Fluoroelastomer	1" Seal, Hi-Temp
8260914HT	DE11605	1.00"	1.31"	H	Fluoroelastomer	1" Seal, Hi-Temp
499A912AFP5	DE5312	1.25"	1.63"	S	Nitrile	1 1/4" Seal
16391341-2	DE4406	1.25"	1.63"	S	Nitrile	1 1/4" Seal
8260915	DE10085	1.25"	1.63"	S	Nitrile	1 1/2" Seal
16391317-2	DE4398	1.50"	1.88"	S	Nitrile	1 1/2" Seal
499A912AFP6HT	DE50076	1.50"	1.88"	H	Fluoroelastomer	1 1/2" Seal, Hi-Temp
8285116	DE11303	1.50"	1.88"	H	Nitrile	1 1/2" Seal
9544432	DE11303	1.50"	1.88"	H	Fluoroelastomer	1 1/2" Seal, Hi-Temp

# TRACTION MOTOR COVERS & GASKETS

Durogard Seals are designed to keep out snow, water, dirt and protect from overhaul to overhaul. Because there is no loss of air, maximum air goes through the engine.

- Resists oil and ozone
- Flexible from 50°F below to 245°F – (snap off old - snap on new)
- Covers and seals available as one
- Prevents flash overs
- Motors are cleaner and run cooler

## Keep Engines Cleaner!

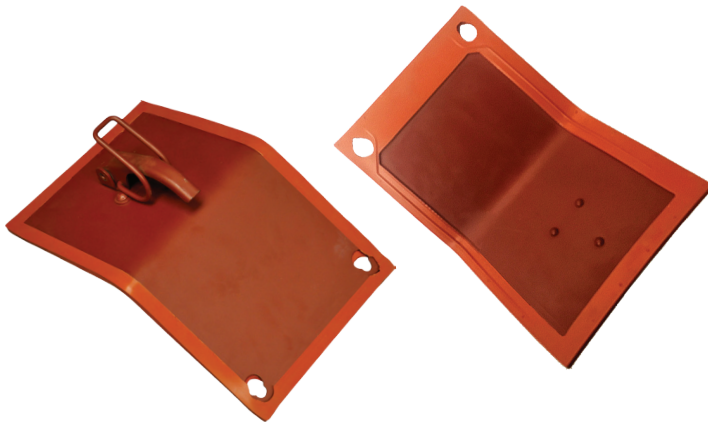

## Traction Motor Cover - Gasket Seals Only

OEM Cover Assembly #	Description	Rubber Seal	Felt Seal
8117405	Gasket Seal Only for EMD #8117405	DE11792	DE1920
8183868	Gasket Seal Only for EMD #8183868	DE11791	DE1166
8204661	Gasket Seal Only for EMD #8204661	DE11791	DE1278
8204665	Gasket Seal Only for EMD #8204665	DE11789	DE2142
8300010	Gasket Seal Only for EMD #8300010	DE11788	DE1330
8300011	Gasket Seal Only for EMD #8300011	DE11787	DE1179
8300013	Gasket Seal Only for EMD #8300013	DE11790	DE2177
8408599	Gasket Seal Only for EMD #8408599	DE11794	N/A
8408688	Gasket Seal Only for EMD #8408688	DE11793	N/A
8467155	Gasket Seal Only for EMD #8467155	DE12086	DE13240
8467156	Gasket Seal Only for EMD #8467156	DE12087	DE1179

# TRACTION MOTOR COVERS & GASKETS

## New Traction Motor Covers

OEM Cover Assembly #	Description	Cover Only - No Seal	Cover w/ Rubber Seal	Cover w/ Felt Seal
8117405	New Painted Traction Motor Cover	DE11856	DE11850	DE11899
8183868	New Painted Traction Motor Cover	DE11834	DE11939	DE11904
8204661	New Painted Traction Motor Cover	DE11832	DE11847	DE11896
8204665	New Painted Traction Motor Cover	DE11833	DE11917	DE11903
8300010	New Painted Traction Motor Cover	DE11835	N/A	DE11898
8300011	New Painted Traction Motor Cover	DE11837	DE11849	DE11905
8300013	New Painted Traction Motor Cover	DE11831	DE11848	DE11897
8467155	New Painted Traction Motor Cover	DE12078	DE11851	DE11901
8467156	New Painted Traction Motor Cover	DE12077	DE11852	DE11902

## Repair & Return Traction Motor Covers

OEM Cover Assembly #	Description	Cover Only - No Seal	Cover w/ Rubber Seal	Cover w/ Felt Seal
8117405	R&R Painted Traction Motor Cover	DE12022	DE12100	DE12093
8183868	R&R Painted Traction Motor Cover	DE12025	DE12103	DE12096
8204661	R&R Painted Traction Motor Cover	DE12023	DE12101	DE12094
8204665	R&R Painted Traction Motor Cover	DE12027	DE12105	DE12098
8300010	R&R Painted Traction Motor Cover	DE12024	DE12102	DE12095
8300011	R&R Painted Traction Motor Cover	DE12026	DE12104	DE12097
8300013	R&R Painted Traction Motor Cover	DE12021	DE12099	DE12092
8408599	R&R Painted Traction Motor Cover	DE13819	DE13832	N/A
8408688	R&R Painted Traction Motor Cover	DE13812	DE13850	N/A
8467155	R&R Painted Traction Motor Cover	DE13009	DE13011	DE11854
8467156	R&R Painted Traction Motor Cover	DE12085	DE13010	DE11855

# CLEATS & GROMMETS

## Durox Cable Cleats

Wooden cleats tend to crack and allow moisture to penetrate through to cable. Most existing rubber materials are not dielectric and allow for current to pass from cable to frame.

Durox cleats feature a specially designed, dense rubber compound that prevents water and oil saturation and is dielectric providing complete insulation from cable to frame. Fiberglass cleats also available by special request where increased rigidity is required.



### \*Additional Cleats Available Upon Request

OEM #	Durox #	Description	Length	Width	Height	Bolt Hole Center	Mounting Hole Dia.
8364277	DE11779	CLEAT: (6) Half round cutouts - (4) 9/32" radius, (2) 7/32" radius; middle position	8-1/8"	3/4"	3/4"	7-1/8"	3/8"
8364278	DE11780	CLEAT: (3) Half round cutouts - (1) 9/16" radius, (1) 7/8" radius, (1) 11/16" radius	8-1/8"	1-1/4"	3/4"	7-1/8"	3/8"
8364279	DE11814	CLEAT: (4) Half round cutouts - 11/16" radius	8-1/8"	3/4"	7/8"	7-1/8"	3/8"
8368678	DE13770	CLEAT: (2) Half round - Cable. Rubber - 19/32" radius	4-1/2"	1"	1"	3-1/2"	3/8"
8368684	DE13694	CLEAT: (4) Half round - Cable. Rubber - 19/32" radius	7-3/8"	1"	1"	6-3/8"	3/8"
8471872	DE11782	CLEAT: (3) Half round cutouts - 7/16" radius	4-7/8"	1"	3/4"	4"	7/16"
8473241	DE11781	CLEAT: (3) Half round cutouts - 19/32" radius	6-3/16"	1"	1"	5-3/16"	7/16"
8474056	DE11718	CLEAT: (2) Half round cutouts - 21/32" radius, 60 durometer	4-5/8"	1"	1"	3-5/8"	7/16"
8474056	DE14536	CLEAT: (2) Half round cutouts - 21/32" radius, 80 durometer	4-5/8"	1"	1"	3-5/8"	7/16"
8474057	DE11719	CLEAT: (3) Half round cutouts - 21/32" radius	6-3/16"	1"	1"	5-3/16"	7/16"
8474058	DE11720	CLEAT: (4) Half round cutouts - 21/32" radius, 60 durometer	7-3/4"	1"	1"	6-3/4"	7/16"
8474058	DE14537	CLEAT: (4) Half round cutouts - 21/32" radius, 80 durometer	7-3/4"	1"	1"	6-3/4"	7/16"
8474058	DE14665	CLEAT: (4) Half round cutouts - 21/32" radius, 80 durometer	7-3/4"	1"	1"	6-3/4"	7/16"
9094305	DE11206	CLEAT: (2) Half round cutouts - 15/32" radius, 60 durometer	4-3/8"	1"	3/4"	3-3/8"	7/16"
9094305	DE14542	CLEAT: (2) Half round cutouts - 15/32" radius, 80 durometer	4-3/8"	1"	3/4"	3-3/8"	7/16"
9094306	DE10196	CLEAT: (3) Half round cutouts - 15/32" radius, 60 durometer	5-9/16"	1"	3/4"	4-9/16"	7/16"
9094306	DE14539	CLEAT: (3) Half round cutouts - 15/32" radius, 80 durometer	5-9/16"	1"	3/4"	4-9/16"	7/16"
9094307	DE11207	CLEAT: (4) Half round cutouts - 15/32" radius, 60 durometer	6-3/4"	1"	3/4"	5-3/4"	7/16"
9094307	DE14541	CLEAT: (4) Half round cutouts - 15/32" radius, 80 durometer	6-3/4"	1"	3/4"	5-3/4"	7/16"
9094309	DE14488	CLEAT: (6) Half round cutouts - 15/32" radius, 80 durometer	9-1/4"	1"	1"	8-1/4"	7/16"
9094310	DE11721	CLEAT: (7) Half round cutouts - 15/32" radius	10-1/2"	1"	1"	9-1/2"	7/16"
9515667	DE14487	CLEAT: (1) Rectangular cutout, 1" deep x 1-3/4" wide, 80 durometer	3-3/4"	1-3/16"	1 7/16"	2-3/4"	7/16"
9529197	DE14549	CLEAT: (4) Half round cutouts - 17/32" radius, 80 durometer	6-3/4"	1"	3/4"	5-3/4"	7/16"
40111582	DE14550	CLEAT: (2) Hole for 550 Cable, 80 durometer	3-15/16"	1-1/4"	11/16"	3-1/16"	3/8"



# PRESSURE GAUGES

## Durox “Rugged Heavy” Liquid Filled & Dry Pressure Gauges



**Accuracy:** (+/-) 1.5% full scale on 2 1/2” and (+/-) 1% on scale on 4”

**Crystal:** Shatter resistant plexiglass

**Movement:** All brass

**Bourbon Tube:** Phosphor bronze on 2 1/2” & 316SS on 4” above 800 PSI

**Liquid Filled:** 96% Pure glycerine with 4% distilled water

**Case:** Solid one piece, die cast brass hermetically sealed

**Connection:** 1/4” NPT bottom or back

**Pressure Ranges:** Vacuum and compound to 300 PSI, pressure to 15,000 PSI

**Ambient Temp:** 0° F(-17.8° C) to 180° F(82.2° C) –40° F (-40° C) is available

**Working Pressure:** Should be limited to 60% of dial range

**Application:** Perform extremely well under high vibration, pulsation and shock loading applications. Recommended for all diesel engine applications and all shop applications including: fuel oil, crankcase oil, lube oil, steam, water, gas, air, hydraulic and all other gaseous and liquid media that are non-corrosive to copper alloys.

**Warranty:** Exclusive 3 year warranty on all liquid filled pressure gauges

**Repair:** Gauges are repairable with a 12 month repair warranty

**Options:** Panel mounting or flush

**Also Available:** Standard dry gauges in sizes from 1 1/2” through 4” stainless steel liquid filled gauges in sizes 2 1/2” through 6”.

OEM #	Durox #	Gauge Type	Gauge Size	Pressure Range	Case Material	Connection	Graduation Intervals	Application
<b>Lube Oil</b>								
8015552	DE1007	Dry	3 1/2 “	0-160 PSI	Black Painted Steel Case & Cover Ring	1/4” NPT Bottom	4 PSI 50 kPa	Lube Oil Pressure
8015552	DE1008	Glycerine Filled	3 1/2 “	0-160 PSI	Die Cast Brass	1/4” NPT Bottom	2 PSI 20 kPa	Lube Oil Pressure
8024624	DE1009	Dry	3 1/2 “	0-100 PSI	Black Painted Steel Case & Cover Ring	1/4” NPT Bottom	2 PSI 20 kPa	Lube Oil Pressure
8024624	DE1010	Glycerine Filled	3 1/2 “	0-100 PSI	Black Painted Steel Case & Cover Ring	1/4” NPT Bottom	2 PSI 20 kPa	Lube Oil Pressure
8032123	DE1018	Dry	3 1/2 “	0-160 PSI	Black Painted Steel Case & Cover Ring	1/4” NPT Bottom	2 PSI 20 kPa	Lube Oil Pressure
8032123	DE1019	Glycerine Filled	3 1/2 “	0-160 PSI	Black Painted Steel Case & Cover Ring	1/4” NPT Bottom	2 PSI 20 kPa	Lube Oil Pressure



# PRESSURE GAUGES

OEM #	Durox #	Gauge Type	Gauge Size	Pressure Range	Case Material	Connection	Graduation Intervals	Application
<b>Lube Oil (continued)</b>								
8052920	DE1026	Dry	3 1/2 "	0-200 PSI	Black Painted Steel Case & Cover Ring	1/4" NPT Bottom	4 PSI 40 kPa	Lube Oil Pressure
8052920	DE1027	Glycerine Filled	3 1/2 "	0-200 PSI	Die Cast Brass	1/4" NPT Bottom	4 PSI	Lube Oil Pressure
8054172	DE1046	Dry	3 1/2 "	0-200 PSI	Black Painted Steel Case & Cover Ring	1/4" NPT Bottom	4 PSI 40 kPa	Lube Oil Pressure
8231594	DE1048	Dry	3 1/2 "	0-160 PSI 0-11 Kg/CM2	Black Painted Steel Case & Cover Ring	1/4" NPT Bottom	4 PSI 50 kPa	Lube Oil Pressure
8231594	DE1049	Glycerine Filled	3 1/2 "	0-160 PSI 0-11 Kg/CM2	Die Cast Brass	1/4" NPT Bottom	3 PSI 20 kPa	Lube Oil Pressure
8232099	DE1056	Dry	3 1/2 "	0-160 PSI 0-7 Kg	Black Painted Steel Case & Cover Ring	1/4" NPT Bottom	2 PSI 20 kPa	Lube Oil Pressure
8232099	DE1057	Glycerine Filled	3 1/2 "	0-160 PSI 0-7 Kg	Black Painted Steel Case & Cover Ring	1/4" NPT Bottom	2 PSI 20 kPa	Lube Oil Pressure
8265663	DE1070	Dry	3 1/2 "	0-100 PSI	Black Painted Steel Case & Cover Ring	1/4" NPT Bottom	2 PSI 20 kPa	Lube Oil Pressure
8265663	DE1071	Glycerine Filled	3 1/2 "	0-100 PSI	Black Painted Steel Case & Cover Ring	1/4" NPT Bottom	2 PSI 20 kPa	Lube Oil Pressure
8324170	DE1079	Dry	3 1/2 "	0-160 PSI	Black Painted Steel Case & Cover Ring	1/4" NPT Bottom	4 PSI 50 kPa	Lube Oil Pressure
8324170	DE1080	Glycerine Filled	3 1/2 "	0-160 PSI	Die Cast Brass	1/4" NPT Bottom	4 PSI 20 kPa	Lube Oil Pressure
8262088	DE1066	Dry	4 1/2 "	0-100 PSI	Black Painted Steel Case & Cover Ring	1/4" NPT Bottom	2 PSI 20 kPa	Lube Oil Pressure
8262088	DE1067	Glycerine Filled	4 1/2 "	0-100 PSI	Black Painted Steel Case & Cover Ring	1/4" NPT Bottom	2 PSI 20 kPa	Lube Oil Pressure
<b>Lube Oil Suction</b>								
8098757	DE1028	Dry	3 1/2 "	0-30" vacuum	ABS Case	1/4" NPT Bottom	.5 PSI 5 kPa	Lube Oil Suction
<b>Air Pressure</b>								
8337561	DE1516	Dry	2 1/2 "	0-100 PSI	ABS Black Plastic	1/4" NPT Bottom	0-100 PSI 0-700 kPa	Air Pressure
8262089	DE1068	Dry	3 1/2 "	0-200 PSI	Black Painted Steel Case & Cover Ring	1/4" NPT Bottom	4 PSI 40 kPa	Air Pressure
<b>Fuel Oil Pressure</b>								
8032122	DE1011	Dry	3 1/2 "	0-100 PSI	Black Painted Steel Case & Cover Ring	1/4" NPT Bottom	2 PSI 20 kPa	Fuel Oil Pressure
8032122	DE1012	Glycerine Filled	3 1/2 "	0-100 PSI	Black Painted Steel Case & Cover Ring	1/4" NPT Bottom	2 PSI 20 kPa	Fuel Oil Pressure
8104286	DE1087	Glycerine Filled	3 1/2 "	0-60 PSI	Die Cast Brass	1/4" NPT Bottom	1 PSI	Fuel Oil Pressure
8121912	DE1038	Dry	3 1/2 "	0-30 PSI	ABS Case	1/4" NPT Bottom	.5 PSI 5 kPa	Fuel Oil Pressure
8262087	DE1058	Dry	4 1/2 "	0-100 PSI	Black Painted Steel Case & Cover Ring	1/4" NPT Bottom	2 PSI 20 kPa	Fuel Oil Pressure
8262087	DE1060	Glycerine Filled	4 1/2 "	0-100 PSI	Black Painted Steel Case & Cover Ring	1/4" NPT Bottom	2 PSI 20 kPa	Fuel Oil Pressure



# OTHER ENGINE PARTS

---

## Fuel Line

OEM #	Durox #	Description
8160209	DE60034	Line Assembly: Fuel Oil - Manifold to Injector



## Lube Oil Line

OEM #	Durox #	Description
8039842	DE60006	Line Assembly: Lube Oil - Rocker Arm Shaft



## Piston Cooling Tube

OEM #	Durox #	Description
9549578	DE13840	Piston Cooling Tube



# OTHER ENGINE PARTS

## Cylinder Head Seat Ring

OEM #	Durox #	Description
9509180	DE11900	Cylinder Head Seat Ring: 0.192" O.S. (replaces 8419438)
9516094	DE11918	Cylinder Head Seat Ring: 0.018" O.S.
9509803	DE11938	Cylinder Head Seat Ring: 0.038" O.S.



## Water Discharge Elbows & O'Ring Seals

OEM #	Durox #	Description
8414444	DE60105	ELBOW: Water outlet w/ double groove
9317972	DE1316	O'RING: Water outlet elbow to crankcase - Nitrile (Black)
9317972	DE11644	O'RING: Water outlet elbow to crankcase - AFLAS® (Yellow)
8305815	DE2035	O'RING: Elbow to Head - Silicone (Red)
8305815	DE12034	O'RING: Elbow to Head - Fluoroelastomer (Green)



## Sand Nozzles

OEM #	Durox #	Description
8328553	DE2020	Sand Nozzle only
40020060	DE2021	Sand Nozzle w/ Clamp



## OTHER ENGINE PARTS

---

### Durox Brake Handles

**DE742**  
Offset Independent



**DE422**  
Independent



**DE774**  
Automatic



**DE60043**  
Reverser



# DUROX ENHANCED PRODUCTS

## Durox Vectors® & Corners

The Durox patented “Vector®” collects oil-splash from the rocker and cam components before it migrates to leak prone areas. Salvaging what normally is “lost lubrication”, the Vector® then redirects oil-flow back to the cam lobes, rocker arm rollers and valve bridge components.

A universal fit and a tool-free application make Durox Vectors® a cost effective method for improving EMD engine performance.

### Helps to Prevent:

- Top-deck gasket leaks
- Upper-deck housing leaks
- Rocker/cam component wear

Durox #	Description
DE13000	Vector® Cover
DE13101	Corner Piece (Left)
DE13102	Corner Piece (Right)
DE13108	KIT - 8 Cylinder
DE13112	KIT - 12 Cylinder
DE13116	KIT - 16 Cylinder
DE13120	KIT - 20 Cylinder



## Durox Layshaft Seal with Oil Deflector Sleeve

The existing layshaft seal design is a cork gasket that seals for a limited time before it becomes saturated with oil and begins to leak. This is a real problem because of the time required to remove the injector control bracket assembly in order to replace the gasket.

The Durox Layshaft Seal with Oil Deflector Sleeve (#DE11811) is a rubber seal with beads that is impervious to oil. The sleeve acts as an oil deflector that prevents oil from leaking out of the application. The combined rubber seal and oil deflecting sleeve is designed to remain “leak free” from overhaul to overhaul.



#DE11811

# DUROX ENHANCED PRODUCTS

## Durox Self-Torquing Fuel Site Bowl Clevis & Seal Kit

The original design of the fuel site bowl clevis requires users to make a judgment call as to how much torque to apply. Too tight and the glass bowl cracks, too loose and the application leaks - either can result in a fuel leak. In addition, the simple design of the square cut gasket used for the fuel site bowl seal easily allows the bowl to slide off, which also causes leaks.

- **Durox #DE13527: Self-Torquing Clevis** tightens until the proper torque limit is reached and then spins harmlessly, totally eliminating the possibility of under or over-torquing the application.
- **Durox #DE10864: Fuel Sight Bowl Seal** is contoured so that the bowl fits into the seal and eliminates the possibility of it slipping and leaking.
- **Durox #DE32515: Self-Torquing Fuel Sight Bowl Clevis & Seal Kit** eliminates all problems that are associated with this application and will remain “leak free” from overhaul to overhaul.



## Durox Governor Plug Protector

Governor plug failures are often caused by oil and dirt from normal engine operation, strong cleansers and high-pressure water and steam used for engine cleaning; all which can penetrate governor plugs and cause the connectors to short out. The Durox Governor Plug Protector:

- Provides a water-tight seal.
- Protects the plug from penetration by disruptive elements.
- Helps support the cable to relieve stress on the plug connection.
- Is easily installed in the field using the installation tool without removing the plug from the cable.

Durox #	Description
DE3829	Kit, 16 PIN
DE3613	Protector, 16 PIN
DE3810	Kit, 12 PIN
DE3807	Protector, 12 PIN
DE3826	Collar
DE3891	Kit, Collar
DE3619	Installation Tool
DE3615	Kit, Internally Mounted



# DUROX ENHANCED PRODUCTS

---

## Durox Plastic Covers

Eliminate the time and labor expense required to fabricate cardboard and duct tape covers with Durox reusable plastic covers that snap right into place. Additional covers and magnetic paint shields are available upon request.

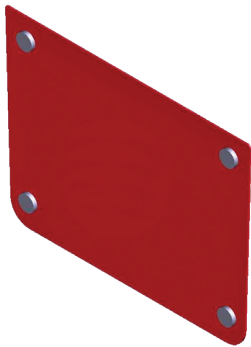

**DE3591**  
EMD WICK

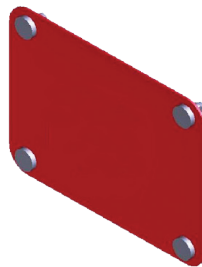

**DE3592**  
GE WICK

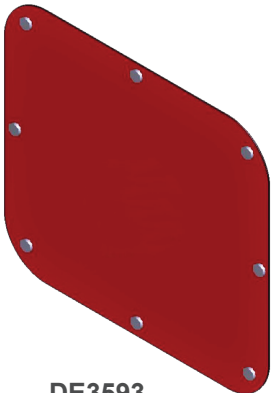

**DE3593**  
EMD AIR BOX

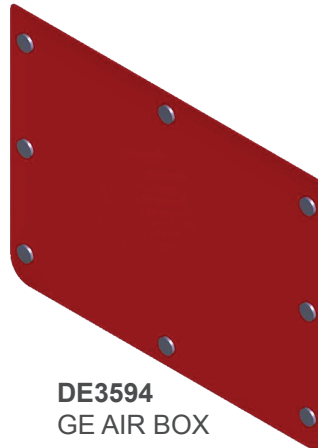

**DE3594**  
GE AIR BOX



**DE3595**  
EMD AXLE



**DE3746**  
GE AXLE

# DUROX ENHANCED PRODUCTS

## Durox Magnetic Signs



### Reflective in the Dark



Durox #	Magnetic Sign Description	Lettering Color	Background Color
DE30160	SIGN ASSEMBLY, "FLOOR OUT"	White	Red
DE30168	SIGN ASSEMBLY, "600 VOLTS"	White	Red
DE30169	SIGN ASSEMBLY, "BLANK"	White	Red
DE31099	SIGN ASSEMBLY, "STOP"	White	Blue
DE31112	SIGN ASSEMBLY, "BATTERY DOOR UP"	White	Red
DE31117	SIGN ASSEMBLY, "DANGER HIGH VOLTAGE"	White	Red
DE31120	SIGN ASSEMBLY, "DO NOT BAR ENGINE"	White	Red
DE31123	SIGN ASSEMBLY, "DANGER FLOOR OUT"	White	Red
DE31170	SIGN ASSEMBLY, "CAUTION HOT METAL"	White	Red
DE31207	SIGN ASSEMBLY, "STOP MEN AT WORK!"	White	Blue
DE31302	SIGN ASSEMBLY, "DANGER HYPOT TEST"	White	Red
DE31399	SIGN ASSEMBLY, "DRAINED"	White	Red
DE31439	SIGN ASSEMBLY, "STOP LARGE"	White	Blue
DE31447	SIGN ASSEMBLY, "NOT OILED"	Black	Yellow
DE31463	SIGN ASSEMBLY, "CAUTION HYPOT"	Red	White
DE31775	SIGN ASSEMBLY, "STATIC TEST"	White	Red
DE31840	SIGN ASSEMBLY, "EQUIPMENT"	White	Red
DE31871	SIGN ASSEMBLY, "HOT METAL"	Black	Yellow
DE32014	SIGN ASSEMBLY, "CAUTION FUEL TANK RP"	White	Red
DE32098	SIGN ASSEMBLY, "CAUTION HATCH OPEN"	Black	Yellow
DE32117	SIGN ASSEMBLY, "TRUCKS CUT OUT"	White	Blue
DE32122	SIGN ASSEMBLY, "WAYSIDE CONNECTED"	White	Blue
DE32125	SIGN ASSEMBLY, "CAB SIGNAL TEST"	White	Blue
DE32128	SIGN ASSEMBLY, "TOILET SERVICE"	White	Blue
DE32131	SIGN ASSEMBLY, "AIR TEST"	White	Blue
DE32132	SIGN ASSEMBLY, "MEN ON ROOF"	White	Blue
DE32135	SIGN ASSEMBLY, "FLOOR OPEN"	White	Blue
DE32137	SIGN ASSEMBLY, "AIR VALVES REMOVED"	White	Blue
DE32140	SIGN ASSEMBLY, "TRUCK WORK"	White	Blue
DE32142	SIGN ASSEMBLY, "LOAD BOX CONNECTED"	White	Blue
DE32144	SIGN ASSEMBLY, "BATTERY CHARGER CONNECTED"	White	Blue
DE32158	SIGN ASSEMBLY, "CAUTION OIL SAMPLE VALVE OPEN"	White	Red
DE32658	SIGN ASSEMBLY, "CAUTION HOT"	Red	Yellow



## EMD<sup>†</sup> LOCOMOTIVE GASKET & SEAL OVERHAUL KITS

### Kit Ordering Information:

OEM Part #	Standard	Swellex + Standard	Swellex + HP	Description	Quantity
<b>Kits</b>					

OEM Gasket or Rubber

Swellex Gasket & OEM Rubber

Swellex Gasket & High Performance Fluoroelastomer Rubber

OEM Part #	Standard	High Performance	Description	Quantity
<b>Gaskets &amp; Seals</b>				

OEM Gasket or Rubber

Swellex Gasket and / or High Performance Fluoroelastomer Rubber

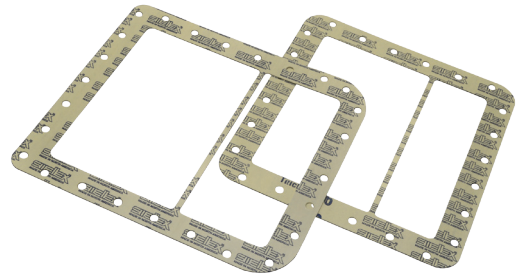
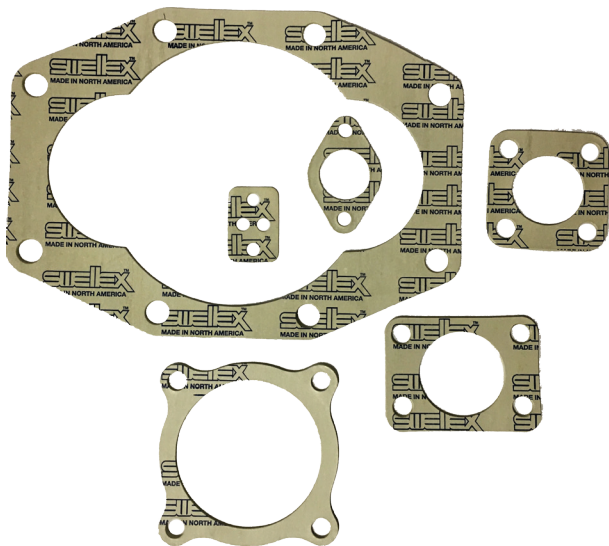

# EMD<sup>†</sup> 16-567D1,D2,D3,D4

OEM Part #	Standard	Swellex + Standard	Swellex + HP	Description	D1	D2	D3	D3A
<b>Kits</b>					<b>Quantity per Engine</b>			
9583686	DE10018	DE10824	DE13863	KIT: Power Assembly Installation (Old Style CTVS)	16	16	16	16
or	or	or	or	or	or	or	or	or
9583686	DE13018	DE13020	DE13019	KIT: Power Assembly Installation (New Style CTVS)	16	16	16	16
9580706	DE1913	DE10341	DE10993	KIT: Overspeed Trip Housing	1	1	1	1
9580698	DE1815	DE10659	N/A	KIT: Camshaft Drive Housing	1	-	-	-
8306359	DE2051	DE10855	N/A	KIT: Camshaft Drive Housing	-	1	1	1
9580741	DE1793	DE10837	DE10995	KIT: Lube Oil Strainer Element - Replaces 8496989		1	1	1
9580742	DE2046	DE10339	DE10992	KIT: Lube Oil Suction Strainer - Replaces 8496990	1	1	1	1
9580708	DE1922	DE10723	DE11002	KIT: Piston Cooling and Pressure Pump	1	-	-	-
9580715	DE2044	DE10337	DE10932	KIT: Piston Cooling and Pressure Pump	-	1	1	1
8210018	DE1795	DE10649	N/A	KIT: Lube Oil Scavenging Pump	1	-	-	-
8306357	DE1757	DE10269	N/A	KIT: Lube Oil Scavenging Pump	-	1	1	1
9580709	DE1933	DE10729	N/A	KIT: Lube Oil Separator	1	-	-	-
9580717	DE2052	DE10342	N/A	KIT: Lube Oil Separator	-	1	1	1
9580714	DE1982	DE10749	N/A	KIT: Water Pump	2	2	2	2
9580697	DE1814	DE10271	N/A	KIT: Fuel Oil Manifold	1	1	1	1
8340405	DE2071	DE10338	DE10991	KIT: Fuel Oil Filter (Viscose and Spin-On)	1	1	1	1
9580711	DE1955	DE1146	N/A	KIT: Cylinder Head Cover and Support Frame - Square Inside Corners	1	1	1	1
or	or	or	or	or	or	or	or	or
9087946	DE2133	DE10340	DE14510	KIT: Cylinder Head Cover and Support Frame - Round Inside Corners	1	1	1	1
9580710	DE1934	DE10272	DE10994	KIT: Accessory Drive Housing	1	1	1	1
8209989	DE1773	DE10638	N/A	KIT: Auxiliary Generator Drive	1	-	-	-
9580721	DE1956	DE10273	N/A	KIT: Governor Drive	1	1	1	1
9580694	DE1772	DE10637	N/A	KIT: Engine Blower	2	-	-	-
9580720	DE1557	DE10781	DE11006	KIT: Turbocharger Changeout	-	1	-	-
9580719	DE2062	DE10780	DE10933	KIT: Turbocharger Changeout	-	-	1	1
8306238	DE2042	DE10772	N/A	KIT: Aftercooler Changeout - 2 Flange Header	-	-	2	2
8306239	DE2043	DE10773	N/A	KIT: Aftercooler Changeout - 4 Flange Header	-	-	2	-

OEM Part #	Standard	High Performance	Description	D1	D2	D3	D3A
<b>Gaskets &amp; Seals</b>				<b>Quantity per Engine</b>			
8081594	DE1434	DE10239	GASKET: Oil Line Mounting	6	6	6	6
8159200	DE1675	DE10202	GASKET: Flange Mounting	2	2	2	2
8187010	DE1712	DE1712	SEAL: Silicon Crankcase to Oil Pan	2	2	2	2
8195120	DE1734	DE10625	GASKET: Plate Mounting	1	1	1	1
8198078	DE10110	DE10194	O-RING: Air Box Drain	2	2	2	2
8204419	DE1745	DE10630	GASKET: Flange Mounting	2	2	2	2
8291349	DE2180	DE10041	GASKET: Handhole Cover	32	32	32	32
8433272	DE1929	DE10958	SEAL: Water Manifold, Camshaft Drive End	4	4	4	4
8476400	N/A	DE31900	GASKET: Head to Liner w/ Integrated Grommet Seals	16	16	16	16
9570676	DE2083	DE10245	GASKET: Cover Mounting	1	1	1	1
9570754	DE1994	DE10240	GASKET: Manifold Mounting	1	1	1	1
9570778	DE10006	DE10205	GASKET: Blind Flange	1	1	1	1

<sup>†</sup> Used for reference only

OEM Part #	Standard	Swellex + Standard	Swellex + HP	Description	Quantity
<b>Kits</b>					
9583686	DE10018	DE10824	DE13863	KIT: Power Assembly Installation (Old Style CTVS)	8
or	or	or	or	or	or
9583686	DE13018	DE13020	DE13019	KIT: Power Assembly Installation (New Style CTVS)	8
9580704	DE1257	DE10999	N/A	KIT: Overspeed Trip Housing	1
9580698	DE1815	DE10659	N/A	KIT: Camshaft Drive Housing	1
9580741	DE1793	DE10837	DE10995	KIT: Lube Oil Strainer Element - Replaces 8496989	1
9580742	DE2046	DE10339	DE10992	KIT: Lube Oil Suction Strainer - Replaces 8496990	1
9580708	DE1922	DE10723	DE11002	KIT: Piston Cooling & Pressure Pump	1
8210308	DE11290	DE11287	N/A	KIT: Lube Oil Scavenging Pump	1
9580709	DE1933	DE10729	N/A	KIT: Lube Oil Separator	1
9580724	DE10054	DE10797	N/A	KIT: Water Pump	1
9580697	DE1814	DE10271	N/A	KIT: Fuel Oil Manifold	1
8340405	DE2071	DE10338	DE10991	KIT: Fuel Oil Filter (Viscose & Spin-On)	1
9087944	DE1570	DE1149	DE14592	KIT: Head Frame with Round Corners (8 Cylinder)	1
or	or	or	or	or	or
9580712	DE10866	DE11001	N/A	KIT: Head Frame with Square Corners (8 Cylinder)	1
9580705	DE1905	DE10715	DE11005	KIT: Accessory Drive Housing	1
40001582	DE1773	DE10638	N/A	KIT: Auxiliary Generator Drive	1
9580721	DE1956	DE10273	N/A	KIT: Governor Drive	1
9580694	DE1772	DE10637	N/A	KIT: Engine Blower	1

OEM Part #	Standard	High Performance	Description	Quantity
<b>Gaskets &amp; Seals</b>				
8081594	DE1434	DE10239	GASKET: Mount for Oil Line	3
8159200	DE1675	DE10202	GASKET: Flange	2
8187007	DE1707	N/A	SEAL: Crankcase to Oil Pan (Silicone, 8 Cylinder)	2
8195120	DE1734	DE10625	GASKET: Crankcase Mounting	1
8198078	DE10110	DE10194	O-RING: Airbox Drain	2
8204419	DE1745	DE10630	GASKET: Crankcase Mounting	2
8291349	DE2180	DE10041	GASKET: Handhole Cover	16
8356239	DE2098	DE10304	GASKET: Flange	1
8433272	DE1929	DE10958	SEAL: Water Manifold	4
8476400	N/A	DE31900	GASKET KIT: Head to Liner with Integrated Grommet Seals	8
9570676	DE2083	DE10245	GASKET	1
9570754	DE1994	DE10240	GASKET: Lube Oil Manifold Mounting	1
9570765	DE1290	DE10996	GASKET	5
9570776	DE10065	DE10246	GASKET	1
9570778	DE10006	DE10205	GASKET	1

## EMD<sup>†</sup> 8-645E3/E3B/E3C (Rail)

OEM Part #	Standard	Swellex + Standard	Swellex + HP	Description	Quantity
<b>Kits</b>					
9583686	DE10018	DE10824	DE13863	KIT: Power Assembly Installation (Old Style CTVS)	8
or	or	or	or	or	or
9583686	DE13018	DE13020	DE13019	KIT: Power Assembly Installation (New Style CTVS)	8
9580704	DE1257	DE10999	N/A	KIT: Overspeed Trip Housing	1
9580725	DE2122	DE10267	N/A	KIT: Camshaft Drive Housing	1
9580741	DE1793	DE10837	DE10995	KIT: Lube Oil Strainer Element - Replaces 8496989	1
9580742	DE2046	DE10339	DE10992	KIT: Lube Oil Suction Strainer - Replaces 8496990	1
9580696	DE1804	DE10653	DE11003	KIT: Piston Cooling & Pressure Pump	1
8210019	DE1801	DE10650	N/A	KIT: Lube Oil Scavenging Pump	1
9580717	DE2052	DE10342	N/A	KIT: Lube Oil Separator	1
9571961	DE11292	DE11289	N/A	KIT: Water Pump	1
9580697	DE1814	DE10271	N/A	KIT: Fuel Oil Manifold	1
8340405	DE2071	DE10338	DE10991	KIT: Fuel Oil Filter (Viscose & Spin-on)	1
9087944	DE1570	DE1149	DE14592	KIT: Head Frame with Round Corners (8 Cylinder)	1
or	or	or	or	or	or
9580712	DE10866	DE11001	N/A	KIT: Head Frame with Square Corners (8 Cylinder)	1
9580705	DE1905	DE10715	DE11005	KIT: Accessory Drive Housing	1
9580721	DE1956	DE10273	N/A	KIT: Governor Drive	1
8414907	DE10034	DE10833	DE11272	KIT: Turbocharger Changeout	1
8306238	DE2042	DE10772	N/A	KIT: Aftercooler Changeout	2

OEM Part #	Standard	High Performance	Description	Quantity
<b>Gaskets &amp; Seals</b>				
8081594	DE1434	DE10239	GASKET: Mount for Oil Line	3
8159200	DE1675	DE10202	GASKET: Flange	2
8187007	DE1707	N/A	SEAL: Crankcase to Oil Pan (Silicone, 8 Cylinder)	2
8195120	DE1734	DE10625	GASKET: Crankcase Mounting	1
8198078	DE10110	DE10194	O-RING: Airbox Drain	2
8204419	DE1745	DE10630	GASKET: Crankcase Mounting	2
8291349	DE2180	DE10041	GASKET: Handhole Cover	16
8356239	DE2098	DE10304	GASKET: Flange	1
8433272	DE1929	DE10958	SEAL: Water Manifold	4
8476400	N/A	DE31900	GASKET KIT: Head to Liner with Integrated Grommet Seals	8
9570676	DE2083	DE10245	GASKET	1
9570754	DE1994	DE10240	GASKET: Lube Oil Manifold Mounting	1
9570765	DE1290	DE10996	GASKET	5
9570776	DE10065	DE10246	GASKET	1
9570778	DE10006	DE10205	GASKET	1

<sup>†</sup> Used for reference only

OEM Part #	Standard	Swellex + Standard	Swellex + HP	Description	Quantity
<b>Kits</b>					
9583686	DE10018	DE10824	DE13863	KIT: Power Assembly Installation (Old Style CTVS)	12
or	or	or	or	or	or
9583686	DE13018	DE13020	DE13019	KIT: Power Assembly Installation (New Style CTVS)	12
9580770	DE11240	DE11322	N/A	KIT: Overspeed Trip Housing with Rear Oil Drains	1
or	or	or	or	or	or
9580706	DE1913	DE10993	N/A	KIT: Overspeed Trip Housing with Bottom Oil Drains	1
9580699	DE10038	DE10660	N/A	KIT: Camshaft Drive Housing	1
9580741	DE1793	DE10837	DE10995	KIT: Lube Oil Strainer Element - Replaces 8496989	1
9580742	DE2046	DE10339	DE10992	KIT: Lube Oil Suction Strainer - Replaces 8496990	1
9580708	DE1922	DE10723	DE11002	KIT: Piston Cooling & Pressure Pump	1
8210019	DE1801	DE10650	N/A	KIT: Lube Oil Scavenging Pump	1
9580709	DE1933	DE10729	N/A	KIT: Lube Oil Separator	1
9580724	DE10054	DE10797	N/A	KIT: Water Pump	2
9580697	DE1814	DE10271	N/A	KIT: Fuel Oil Manifold	1
8340405	DE2071	DE10338	DE10991	KIT: Fuel Oil Filter (Viscose & Spin-On)	1
9580744	DE1569	DE1139	DE14593	KIT: Head Frame with Round Corners (12 Cylinder)	1
or	or	or	or	or	or
9580713	DE10050	DE11000	N/A	KIT: Head Frame with Square Corners (12 Cylinder)	1
9580710	DE1934	DE10272	DE10994	KIT: Accessory Drive Housing	1
8209989	DE1773	DE10638	N/A	KIT: Auxiliary Generator Drive	1
9580721	DE1956	DE10273	N/A	KIT: Governor Drive	1
9580694	DE1772	DE10637	N/A	KIT: Engine Blower	2

OEM Part #	Standard	High Performance	Description	Quantity
<b>Gaskets &amp; Seals</b>				
8081594	DE1434	DE10239	GASKET: Mount for Oil Line	3
8159200	DE1675	DE10202	GASKET: Flange	2
8187009	DE1711	N/A	SEAL: Crankcase to Oil Pan (Silicone, 12 Cylinder)	2
8195120	DE1734	DE10625	GASKET: Crankcase Mounting	1
8198078	DE10110	DE10194	O-RING: Airbox Drain	2
8204419	DE1745	DE10630	GASKET: Crankcase Mounting	2
8291349	DE2180	DE10041	GASKET: Handhole Cover	24
8356239	DE2098	DE10304	GASKET: Flange	1
8433272	DE1929	DE10958	SEAL: Water Manifold	4
8476400	N/A	DE31900	GASKET: Head to Liner with Integrated Grommet Seals	12
9570676	DE2083	DE10245	GASKET	1
9570754	DE1994	DE10240	GASKET: Lube Oil Manifold Mounting	1
9570765	DE1290	DE10996	GASKET	5
9570776	DE10065	DE10246	GASKET	1
9570778	DE10006	DE10205	GASKET	1

## EMD<sup>†</sup> 12-645E3/E3B/E3C (Rail)

OEM Part #	Standard	Swellex + Standard	Swellex + HP	Description	Quantity
<b>Kits</b>					
9583686	DE10018	DE10824	DE13863	KIT: Power Assembly Installation (Old Style CTVS)	12
or	or	or	or	or	or
9583686	DE13018	DE13020	DE13019	KIT: Power Assembly Installation (New Style CTVS)	12
9580770	DE11240	DE11322	N/A	KIT: Overspeed Trip Housing with Rear Oil Drains	1
or	or	or	or	or	or
9580706	DE1913	DE10993	N/A	KIT: Overspeed Trip Housing with Bottom Oil Drains	1
9580725	DE2122	DE10267	N/A	KIT: Camshaft Drive Housing	1
9580741	DE1793	DE10837	DE10995	KIT: Lube Oil Strainer Element - Replaces 8496989	1
9580742	DE2046	DE10339	DE10992	KIT: Lube Oil Suction Strainer - Replaces 8496990	1
9580696	DE1804	DE10653	DE11003	KIT: Piston Cooling and Pressure Pump - Replaces 8210023	1
8210018	DE1795	DE10649	N/A	KIT: Scavenging oil pump	1
9580717	DE2052	DE10342	N/A	KIT: Lube oil separator - Replaces 8306360	1
9580724	DE10054	DE10797	N/A	KIT: Water pump - Replaces 8368757	2
9580697	DE1814	DE10271	N/A	KIT: Fuel oil manifold - Replaces 8210660	1
8340405	DE2071	DE10338	DE10991	KIT: Fuel oil filter - Replaces 9082404	1
9580744	DE1569	DE1139	DE14593	KIT: Cylinder head cover & support frame (round corners) - Replaces 9087945	1
or	or	or	or	or	or
9580713	DE10050	DE11000	N/A	KIT: Cylinder head cover & support frame (square corners) - Replaces 8271651	1
9580710	DE1934	DE10272	DE10994	KIT: Accessory drive housing - Replaces 8261173	1
9580721	DE1956	DE10273	N/A	KIT: Governor drive - Replaces 8336989	1
9580734	DE10034	DE10034	DE11272	KIT: Turbocharger changeout - Replaces 8414907	1
8306238	DE2042	DE10772	N/A	KIT: Aftercooler changeout - 2 flange header	2

OEM Part #	Standard	High Performance	Description	Quantity
<b>Gaskets &amp; Seals</b>				
8081594	DE1434	DE10239	GASKET: Mount for Oil Line	3
8159200	DE1675	DE10202	GASKET: Flange	2
8187009	DE1711	N/A	SEAL: Crankcase to Oil Pan (Silicone, 12 Cylinder)	2
8195120	DE1734	DE10625	GASKET: Crankcase Mounting	1
8198078	DE10110	DE10194	O-RING: Airbox Drain	2
8204419	DE1745	DE10630	GASKET: Crankcase Mounting	2
8291349	DE2180	DE10041	GASKET: Handhole Cover	24
8356239	DE2098	DE10304	GASKET: Flange	1
8433272	DE1929	DE10958	SEAL: Water Manifold	4
8476400	N/A	DE31900	GASKET: Head to Liner with Integrated Grommet Seals	12
9570676	DE2083	DE10245	GASKET	1
9570754	DE1994	DE10240	GASKET: Lube Oil Manifold Mounting	1
9570765	DE1290	DE10996	GASKET	5
9570776	DE10065	DE10246	GASKET	1
9570778	DE10006	DE10205	GASKET	1

<sup>†</sup> Used for reference only

OEM Part #	Standard	Swellex + Standard	Swellex + HP	Description	Quantity
<b>Kits</b>					
9583686	DE10018	DE10824	DE13863	KIT: Power Assembly Installation (Old Style CTVS)	16
or	or	or	or	or	or
9583686	DE13018	DE13020	DE13019	KIT: Power Assembly Installation (New Style CTVS)	16
9580770	DE11240	DE11322	N/A	KIT: Overspeed Trip Housing with Rear Oil Drains	1
or	or	or	or	or	or
9580706	DE1913	DE10993	N/A	KIT: Overspeed Trip Housing with Bottom Oil Drains	1
9580698	DE1815	DE10659	N/A	KIT: Camshaft Drive Housing	1
9580741	DE1793	DE10837	DE10995	KIT: Lube Oil Strainer Element - Replaces 8496989	1
9580742	DE2046	DE10339	DE10992	KIT: Lube Oil Suction Strainer - Replaces 8496990	1
9580708	DE1922	DE10723	DE11002	KIT: Piston Cooling & Pressure Pump	1
8210018	DE1795	DE10649	N/A	KIT: Lube Oil Scavenging Pump	1
9580709	DE1933	DE10729	N/A	KIT: Lube Oil Separator	1
9580724	DE10054	DE10797	N/A	KIT: Water Pump	2
9580697	DE1814	DE10271	N/A	KIT: Fuel Oil Manifold	1
8340405	DE2071	DE10338	DE10991	KIT: Fuel Oil Filter (Viscose & Spin-On)	1
40012903	DE2133	DE10340	N/A	KIT: Head Frame with Round Corners (16 Cylinder)	1
or	or	or	or	or	or
9580711	DE1955	DE1146	N/A	KIT: Head Frame with Square Corners (16 Cylinder)	1
9580710	DE1934	DE10272	DE10994	KIT: Accessory Drive Housing	1
40001582	DE1773	DE10638	N/A	KIT: Auxiliary Generator Drive	1
9580721	DE1956	DE10273	N/A	KIT: Governor Drive	1
9580694	DE1772	DE10637	N/A	KIT: Engine Blower	2

OEM Part #	Standard	High Performance	Description	Quantity
<b>Gaskets &amp; Seals</b>				
8081594	DE1434	DE10239	GASKET: Mount for Oil Line	3
8159200	DE1675	DE10202	GASKET: Flange	2
8187010	DE1712	N/A	SEAL: Crankcase to Oil Pan (Silicone, 16 Cylinder)	2
8195120	DE1734	DE10625	GASKET: Crankcase Mounting	1
8198078	DE10110	DE10194	O-RING: Airbox Drain	2
8204419	DE1745	DE10630	GASKET: Crankcase Mounting	2
8291349	DE2180	DE10041	GASKET: Handhole Cover	32
8356239	DE2098	DE10304	GASKET: Flange	1
8433272	DE1929	DE10958	SEAL: Water Manifold	4
8476400	N/A	DE31900	GASKET: Head to Liner with Integrated Grommet Seals	16
9570676	DE2083	DE10245	GASKET	1
9570754	DE1994	DE10240	GASKET: Lube Oil Manifold Mounting	1
9570765	DE1290	DE10996	GASKET	5
9570776	DE10065	DE10246	GASKET	1
9570778	DE10006	DE10205	GASKET	1

## EMD<sup>†</sup> 16-645E3/E3B (Rail) E4/E4B/E10B (Marine)

OEM Part #	Standard	Swellex + Standard	Swellex + HP	Description	Quantity
<b>Kits</b>					
9583686	DE10018	DE10824	DE13863	KIT: Power Assembly Installation (Old Style CTVS)	16
or	or	or	or	or	or
9583686	DE13018	DE13020	DE13019	KIT: Power Assembly Installation (New Style CTVS)	16
9580725	DE2122	DE10267	N/A	KIT: Camshaft Drive Housing	1
9580770	DE11240	DE11322	N/A	KIT: Overspeed Trip Housing with Rear Oil Drains	1
or	or	or	or	or	or
9580706	DE1913	DE10993	N/A	KIT: Overspeed Trip Housing with Bottom Oil Drains	1
9580741	DE1793	DE10837	DE10995	KIT: Lube Oil Strainer Element - Replaces 8496989	1
9580742	DE2046	DE10339	DE10992	KIT: Lube Oil Suction Strainer - Replaces 8496990	1
9580715	DE2044	DE10337	DE10932	KIT: Piston Cooling & Pressure Pump	1
8306357	DE1757	DE10269	N/A	KIT: Lube Oil Scavenging Pump	1
9580717	DE2052	DE10342	N/A	KIT: Lube Oil Separator	1
9580723	DE2108	DE10270	N/A	KIT: Water Pump	2
9580697	DE1814	DE10271	N/A	KIT: Fuel Oil Manifold	1
8340405	DE2071	DE10338	DE10991	KIT: Fuel Oil Filter (Viscose & Spin-On)	1
40012903	DE2133	DE10340	N/A	KIT: Head Frame with Round Corners (16 Cylinder)	1
or	or	or	or	or	or
9580711	DE1955	DE1146	N/A	KIT: Head Frame with Square Corners (16 Cylinder)	1
9580710	DE1934	DE10272	DE10994	KIT: Accessory Drive Housing	1
9580721	DE1956	DE10273	N/A	KIT: Governor Drive	1
9580730	DE2131	DE10275	DE10934	KIT: Turbocharger Changeout	1
9580722	DE2107	DE10274	N/A	KIT: Aftercooler Changeout	2

OEM Part #	Standard	High Performance	Description	Quantity
<b>Gaskets &amp; Seals</b>				
8081594	DE1434	DE10239	GASKET: Mount for Oil Line	3
8159200	DE1675	DE10202	GASKET: Flange	2
8187010	DE1712	N/A	SEAL: Crankcase to Oil Pan (Silicone, 16 Cylinder)	2
8195120	DE1734	DE10625	GASKET: Crankcase Mounting	1
8198078	DE10110	DE10194	O-RING: Airbox Drain	2
8204419	DE1745	DE10630	GASKET: Crankcase Mounting	2
8291349	DE2180	DE10041	GASKET: Handhole Cover	32
8356239	DE2098	DE10304	GASKET: Flange	1
8433272	DE1929	DE10958	SEAL: Water Manifold	4
8476400	N/A	DE31900	GASKET: Head to Liner with Integrated Grommet Seals	16
9570676	DE2083	DE10245	GASKET	1
9570754	DE1994	DE10240	GASKET: Lube Oil Manifold Mounting	1
9570765	DE1290	DE10996	GASKET	5
9570776	DE10065	DE10246	GASKET	1
9570778	DE10006	DE10205	GASKET	1

<sup>†</sup> Used for reference only



## EMD<sup>†</sup> 20-645E3/E3B (Rail) E4/E4B/E10B (Marine)

OEM Part #	Standard	Swellex + Standard	Swellex + HP	Description	Quantity
<b>Kits</b>					
9583686	DE10018	DE10824	DE13863	KIT: Power Assembly Installation (Old Style CTVS)	20
or	or	or	or	or	or
9583686	DE13018	DE13020	DE13019	KIT: Power Assembly Installation (New Style CTVS)	20
9580770	DE11240	DE11322	N/A	KIT: Overspeed Trip Housing with Rear Oil Drains	1
or	or	or	or	or	or
9580706	DE1913	DE10993	N/A	KIT: Overspeed Trip Housing with Bottom Oil Drains	1
9580725	DE2122	DE10267	N/A	KIT: Camshaft Drive Housing	1
9580741	DE1793	DE10837	DE10995	KIT: Lube Oil Strainer Element - Replaces 8496989	1
9580742	DE2046	DE10339	DE10992	KIT: Lube Oil Suction Strainer - Replaces 8496990	1
9580728	DE10268	DE10268	DE11004	KIT: Piston Cooling and Pressure Pump - Replaces 8375381	1
8306357	DE1757	DE10269	N/A	KIT: Scavenging oil pump	1
9580717	DE2052	DE10342	N/A	KIT: Lube oil separator - Replaces 8306360	1
9580723	DE2108	DE10270	N/A	KIT: Water pump - Replaces 8365648	2
9580697	DE1814	DE10271	N/A	KIT: Fuel oil manifold - Replaces 8210660	1
8340405	DE2071	DE10338	DE10991	KIT: Fuel oil filter - Replaces 9082404	1
9580745	DE1567	DE1147	DE14594	KIT: Cylinder head cover and support frame - Replaces 9087947	1
9580710	DE1934	DE10272	DE10994	KIT: Accessory drive housing - Replaces 8261173	1
9580721	DE1956	DE10273	N/A	KIT: Governor drive - Replaces 8336989	1
9580730	DE2131	DE10275	DE10934	KIT: Turbocharger changeout - Replaces 8380244	1
9580722	DE2107	DE10274	N/A	KIT: Aftercooler changeout - Replaces 8365646	2

OEM Part #	Standard	High Performance	Description	Quantity
<b>Gaskets &amp; Seals</b>				
8081594	DE1434	DE10239	GASKET: Mount for Oil Line	3
8159200	DE1675	DE10202	GASKET: Flange	2
8195120	DE1734	DE10625	GASKET: Crankcase Mounting	1
8198078	DE10110	DE10194	O-RING: Airbox Drain	2
8204419	DE1745	DE10630	GASKET: Crankcase Mounting	2
8291349	DE2180	DE10041	GASKET: Handhole Cover	40
8356239	DE2098	DE10304	GASKET: Flange	1
8360920	DE2104	N/A	SEAL: Crankcase to Oil Pan (Silicone, 20 Cylinder)	2
8433272	DE1929	DE10958	SEAL: Water Manifold	4
8476400	N/A	DE31900	GASKET: Head to Liner with Integrated Grommet Seals	20
9570676	DE2083	DE10245	GASKET	1
9570754	DE1994	DE10240	GASKET: Lube Oil Manifold Mounting	1
9570765	DE1290	DE10996	GASKET	5
9570776	DE10065	DE10246	GASKET	1
9570778	DE10006	DE10205	GASKET	1

# EMD<sup>†</sup> 12-710F59PHI

OEM Part #	Standard	Swellex + Standard	Swellex + HP	Description	Quantity
<b>Kits</b>					
8340405	DE2071	DE10338	DE10991	KIT: Gasket - Fuel oil filter	1
9327287	DE13017	DE13020	DE13019	KIT: Gasket - Power pack installation	12
9575124	DE11570	DE11571	N/A	KIT: Gasket - Overspeed trip housing	1
9575125	DE11257	DE11256	N/A	KIT: Gasket - Camshaft drive housing	1
9575131	DE11601	DE14658	DE11580	KIT: Gasket - Lube oil strainer	1
9575132	DE11258	DE11259	N/A	KIT: Gasket - Lube oil scavenging pump	1
9575134	DE13355	DE13356	N/A	KIT: Gasket - Water pump	1
9575135	DE11299	DE14661	DE11294	KIT: Gasket - Turbocharger change out	1
9580697	DE1814	DE10271	N/A	KIT: Gasket - Fuel oil manifold	1
9580710	DE1934	DE10272	DE10994	KIT: Accessory drive housing	1
9580721	DE1956	DE10273	N/A	KIT: Governor drive (replaces 8336989)	1
9580722	DE2107	DE10274	N/A	KIT: Aftercooler changeout (replaces 8365646)	2
9580723	DE2108	DE10270	N/A	KIT: Gasket - Water pump application	1
9580728	DE1759	DE10268	DE11004	KIT: Gasket - Lube oil pressure and piston cooling pump	1
9580741	DE1793	DE10837	DE10995	KIT: Lube oil strainer element	1
9580744	DE1569	DE1139	DE14593	KIT: Gasket - Cylinder head cover and frame	1
40052430	DE14059	DE14070	N/A	KIT: Gasket - Lube oil separator	1

OEM Part #	Standard	High Performance	Description	Quantity
<b>Gaskets &amp; Seals</b>				
8187009	DE1711	N/A	SEAL: Crankcase to Oil Pan (Silicone, 12 Cylinder)	2
8195120	DE1734	DE10625	GASKET: Crankcase Mounting	1
8198078	DE10110	DE10194	O-RING: Airbox Drain	2
8204419	DE1745	DE10630	GASKET: Crankcase Mounting	2
8291349	DE2180	DE10041	GASKET: Handhole Cover	24
8356239	DE2098	DE10304	GASKET: Flange	1
8433272	DE1929	DE10958	SEAL: Water Manifold	4
9570676	DE2083	DE10245	GASKET	1
9570754	DE1994	DE10240	GASKET: Lube Oil Manifold Mounting	1
9570765	DE1290	DE10996	GASKET	5
9570776	DE10065	DE10246	GASKET	1
9570778	DE10006	DE10205	GASKET	1
40048963	DE1434	DE10239	GASKET: Mount for Oil Line	3
40048969	DE1675	DE10202	GASKET: Flange	2

<sup>†</sup> Used for reference only

OEM Part #	Standard	Swellex + Standard	Swellex + HP	Description	Quantity
<b>Kits</b>					
8340405	DE2071	DE10338	DE10991	KIT: Fuel oil filter (replaces 9082404)	1
9327287	DE13017	DE13020	DE13019	KIT: Gasket, Power assembly installation	16
9575123	DE11617	DE11579	N/A	KIT: Gasket, Lube oil separator	1
9575124	DE11570	DE11571	N/A	KIT: Gasket, Overspeed trip housing	1
9575125	DE11257	DE11256	N/A	KIT: Gasket, Camshaft drive housing	1
9575126	DE14250	DE14249	N/A	KIT: Gasket, Cylinder head cover and support frame	1
9575131	DE11601	DE14658	DE11580	KIT: Gasket, Lube oil strainer	1
9575132	DE11258	DE11259	N/A	KIT: Gasket, Lube oil scavenging pump	1
9575134	DE13355	DE13356	N/A	KIT: Gasket, Water pump	1
9575135	DE11299	DE14661	DE11294	KIT: Gasket, Turbocharger change out	1
9580697	DE1814	DE10271	N/A	KIT: Fuel oil manifold (replaces 8210660)	1
9580710	DE10039	DE10272	DE10994	KIT: Accessory drive housing (replaces 8261173)	1
9580721	DE1956	DE10273	N/A	KIT: Governor drive (replaces 8336989)	1
9580722	DE2107	DE10274	N/A	KIT: Aftercooler changeout (replaces 8365646)	2
9580723	DE2108	DE10270	N/A	KIT: Gasket, Water pump application	1
9580728	DE1759	DE10268	DE11004	KIT: Piston Cooling and Pressure Pump (replaces 8375381)	1
9580741	DE1793	DE10837	DE10995	KIT: Lube Oil Strainer Element - Replaces 8496989	1

OEM Part #	Standard	High Performance	Description	Quantity
<b>Gaskets &amp; Seals</b>				
8081594	DE1434	DE10239	GASKET: Oil line mounting	3
8159200	DE1675	DE10202	GASKET: Flange mounting	2
8187010	DE1712	N/A	SEAL: Crankcase to oil pan	2
8195120	DE1734	DE10625	GASKET: Plate mounting	1
8198078	DE10110	DE10194	SEAL: O-ring, Air box drain	2
8204419	DE1745	DE10630	GASKET: Flange	2
8356239	DE2098	DE10304	GASKET: Flange mounting	1
8433272	DE1929	DE10958	SEAL: Water manifold	4
9570676	DE2083	DE10245	GASKET: Water discharge fitting	1
9570754	DE1994	DE10240	GASKET: Manifold mounting	1
9570765	DE1290	DE10996	GASKET: Tube and flange to filter	5
9570776	DE10065	DE10246	GASKET: Flange mounting	1
9570778	DE10006	DE10205	GASKET: Flange mounting	1
40055466	DE10131	DE10131	GASKET: Chamber to crankcase, exhaust manifold leg	8

# EMD<sup>†</sup> GASKET KITS - BILL OF MATERIALS

OEM #	Qty	Description	Standard	Swellex + Standard	Swellex + HP
<b>8210018</b>	<b>1</b>	<b>KIT: Scavenging oil pump</b>	<b>DE1795</b>	<b>DE10649</b>	<b>DE10649</b>
8028264	1	GASKET: Pump to accessory drive housing cover	DE1101	DE10222	DE10222
8029467	4	GASKET: Pump to inlet and outlet elbows	DE1145	DE10254	DE10254
8074661	1	GASKET: Strainer pipe to oil strainer housing	DE1395	DE10213	DE10213
<b>8210019</b>	<b>1</b>	<b>KIT: Scavenging oil pump</b>	<b>DE1801</b>	<b>DE10650</b>	<b>DE10650</b>
8028264	1	GASKET: Pump to accessory drive housing cover	DE1101	DE10222	DE10222
8029150	4	GASKET: Pump to inlet and outlet elbows	DE1126	DE10296	DE10296
8074661	1	GASKET: Strainer pipe to oil strainer housing	DE1395	DE10213	DE10213
<b>8210308</b>	<b>1</b>	<b>KIT: Scavenging oil pump</b>	<b>DE11290</b>	<b>DE11287</b>	<b>DE11287</b>
8028264	1	GASKET: Pump to accessory drive housing cover	DE1101	DE10222	DE10222
8029467	1	GASKET: Pump to inlet and outlet elbows	DE1145	DE10254	DE10254
8074661	1	GASKET: Strainer pipe to oil strainer housing	DE1395	DE10213	DE10213
<b>8306238</b>	<b>1</b>	<b>KIT: Aftercooler changeout - 2 flange header</b>	<b>DE2042</b>	<b>DE10772</b>	<b>DE10772</b>
8289171	3	GASKET: Inlet pipe to aftercooler and engine "Y"	DE2002	DE10210	DE10210
8357298	1	GASKET: Aftercooler to air duct	DE2097	DE10793	DE10793
<b>8306239</b>	<b>1</b>	<b>KIT: Aftercooler changeout - 4 flange header</b>	<b>DE2043</b>	<b>DE10773</b>	<b>DE10773</b>
8070513	1	GASKET: Engine water outlet to aftercoolers	DE1381	DE10211	DE10211
8261265	1	GASKET: Cover - Inspection plate	DE1942	DE10731	DE10731
8262705	1	GASKET: Inlet pipe flange - Large	DE1945	DE10734	DE10734
8262821	3	GASKET: Inlet pipe flange - Small	DE1947	DE10735	DE10735
8289171	1	GASKET: Flanged "Y" to aftercooler pipes	DE2002	DE10210	DE10210
8357298	1	GASKET: Aftercooler to air duct	DE2097	DE10793	DE10793
<b>8306357</b>	<b>1</b>	<b>KIT: Scavenging oil pump</b>	<b>DE1757</b>	<b>DE10269</b>	<b>DE10269</b>
8028264	1	GASKET: Pump mounting	DE1101	DE10222	DE10222
8074661	1	GASKET: Strainer to scavenging pump elbow	DE1395	DE10213	DE10213
8251951	2	GASKET: Pipe to scavenging pump	DE1903	DE10235	DE10269
<b>8306359</b>	<b>1</b>	<b>KIT: Camshaft Drive Housing</b>	<b>DE2051</b>	<b>DE10855</b>	<b>DE10855</b>
9570635	1	GASKET: Camshaft drive housing to crankcase - Replaces 8081380	DE1430	DE10237	DE10237
9570645	1	GASKET: Oil retainer - Replaces 8175858	DE1695	DE10218	DE10218
9570763	2	GASKET: Lube oil manifold to falter - Replaces 8366330	DE2001	DE10290	DE10290
9570764	1	GASKET: Lube oil filter mounting - Replaces 8366331	DE1995	DE10241	DE10241

<sup>†</sup> Used for reference only

# EMD<sup>†</sup> GASKET KITS - BILL OF MATERIALS

OEM #	Qty	Description	Standard	Swellex + Standard	Swellex + HP
-------	-----	-------------	----------	--------------------	--------------

<b>8340405</b>	<b>1</b>	<b>KIT: Fuel oil filter - Replaces 9082404</b>	<b>DE2071</b>	<b>DE10338</b>	<b>DE10991</b>
8104055	2	GASKET: Bowl to filter body	DE1564	DE1564	DE10864
8104276	2	GASKET: Flange to filter	DE1571	DE10233	DE10233
8104292	1	GASKET: Drain lines to filter	DE1572	DE10234	DE10234
8104300	2	GASKET: Connection block	DE1573	DE10232	DE10232
8177030	2	SEAL: Filter housing to body	DE1409	DE1409	DE10928

<b>8490943</b>	<b>1</b>	<b>KIT: Water pump - With single water pumps only</b>	<b>DE11291</b>	<b>DE11288</b>	<b>DE11288</b>
8028760	1	GASKET: Pump to accessory drive housing cover	DE1112	DE10227	DE10227
8347416	1	GASKET: Pipe to crankcase	DE2076	DE10228	DE10228
8347417	1	GASKET: Pump outlet to pipe	DE2081	DE10207	DE10207
8366785	1	GASKET: Pump inlet to pipe	DE1059	DE10208	DE10208
8454337	1	GASKET: Water drain pipe to elbow	DE11320	DE11239	DE11239

<b>9087944</b>	<b>1</b>	<b>KIT: Cylinder head cover and support frame</b>	<b>DE1570</b>	<b>DE1149</b>	<b>DE14592</b>
9087073	2	SEAL: Cylinder head cover	DE2191	DE2191	DE2191
9570606	2	GASKET: Frame to crankcase - Outside - Replaces 8470793	DE1287	DE10814	DE14587
9570607	2	GASKET: Frame to crankcase - Inside - Replaces 8470794	DE1576	DE1157	DE14588

<b>9327287</b>	<b>1</b>	<b>KIT: Gasket - Power assembly installation</b>	<b>DE13017</b>	<b>DE13020</b>	<b>DE13019</b>
8029167	2	GASKET: Rocker arm oil line to camshaft block	DE1144	DE10217	DE10217
8142354	1	GASKET: Water inlet tube to water manifold	DE1642	DE10229	DE13903
8305815	1	GASKET: Piston cooling tube to lube oil manifold	DE2035	DE2035	DE12034
9316850	2	SEAL: Lower liner - Lower groove	DE1989	DE1989	DE1989
9317972	2	SEAL: Water outlet elbow to crankcase	DE1316	DE1316	DE11644
9570729	2	SEAL: Water outlet elbow	DE1084	DE10226	DE10226
9581769	1	SEAL: Cylinder Test Valve, New Style	DE11760	DE11760	DE11760

<b>9571961</b>	<b>1</b>	<b>KIT: Water pump - With single water pumps only</b>	<b>DE11292</b>	<b>DE11289</b>	<b>DE11289</b>
8028760	1	GASKET: Pump to accessory drive housing cover	DE1112	DE10227	DE10227
8347416	2	GASKET: Inlet elbow	DE2076	DE10228	DE10228
8347417	1	GASKET: Pump outlet to pipe	DE2081	DE10207	DE10207
8366787	1	GASKET: Pump inlet to pipe	DE2115	DE10295	DE10295
8454337	2	GASKET: Water drain pipe to elbow	DE11320	DE11239	DE11239

# EMD<sup>†</sup> GASKET KITS - BILL OF MATERIALS

OEM #	Qty	Description	Standard	Swellex + Standard	Swellex + HP
<b>9575123</b>	<b>1</b>	<b>KIT: Gasket - Lube oil separator</b>	<b>DE11617</b>	<b>DE11579</b>	<b>DE11579</b>
8028760	1	GASKET: Flange - Inlet elbow	DE1112	DE10227	DE10227
8306958	1	GASKET: Elbow to oil separator	DE2053	DE10346	DE10346
8335770	1	GASKET: Separator cover	DE1270	DE10783	DE10783
9570751	3	GASKET: Elbow to ejector tube - Replaces 8271729	DE1961	DE10206	DE10206
9574676	1	GASKET: Ejector to elbow	DE11596	DE11598	DE11598

<b>9575124</b>	<b>1</b>	<b>KIT: Gasket - Overspeed trip housing</b>	<b>DE11570</b>	<b>DE11571</b>	<b>DE11571</b>
8028754	1	SEAL: Oil lockshaft	DE1359	DE1359	DE1359
8028765	1	GASKET: Plate to cover	DE1121	DE10291	DE10291
8028766	1	GASKET: Lockshaft plate	DE1122	DE10292	DE10292
8104276	2	GASKET: Jumper line	DE1571	DE10233	DE10233
8104300	2	GASKET: Jumper line	DE1573	DE10232	DE10232
9529801	1	GASKET: Cover to housing	DE10114	DE10243	DE10243
9529807	2	SEAL: Oil - Rear drain to crankcase	DE10111	DE10998	DE10998
9570616	2	GASKET: Housing to crankcase - Replaces 9529800	DE10113	DE10242	DE10242
9570739	2	GASKET: Fuel lines to manifold blocks (Formerly 8218476) - Replaces 8160114	DE1682	DE10231	DE10231
9571656	1	GASKET: Cover - Tachometer opening - Replaces 8058257	DE1321	DE10293	DE10293

<b>9575125</b>	<b>1</b>	<b>KIT: Gasket - Camshaft drive housing</b>	<b>DE11257</b>	<b>DE11256</b>	<b>DE11256</b>
9570626	1	GASKET: Camshaft drive housing to crankcase	DE11260	DE11261	DE11261
9570645	1	GASKET: Oil retainer - Replaces 8175858	DE1695	DE10218	DE10218
9570677	1	GASKET: Filter to camshaft housing - Replaces 8366424	DE2113	DE10204	DE10204
9570764	1	GASKET: Lube oil filter mounting - Replaces 8366331	DE1995	DE10241	DE10241
40048965	3	GASKET: Manifold to spacer	DE2001	DE10290	DE10290

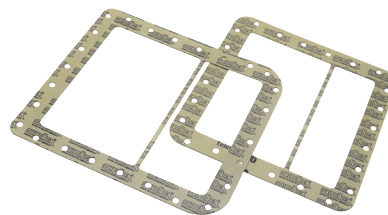

<sup>†</sup> Used for reference only

# EMD<sup>†</sup> GASKET KITS - BILL OF MATERIALS

OEM #	Qty	Description	Standard	Swellex + Standard	Swellex + HP
<b>9575126</b>	<b>1</b>	<b>KIT: Gasket - Cylinder head cover and support frame</b>	<b>DE14250</b>	<b>DE14249</b>	<b>DE14249</b>
9087073	4	SEAL: Cylinder head cover	DE2191	DE13845	DE13845
9570609	2	GASKET: Frame to crankcase - Outer	DE11955	DE10215	DE10215
9570617	2	GASKET.. Head frame support - Inner	DE11564	DE11563	DE11563

<b>9575131</b>	<b>1</b>	<b>KIT: Gasket - Lube oil strainer</b>	<b>DE11601</b>	<b>DE14658</b>	<b>DE11580</b>
8029467	4	GASKET: Pipe to scavenging pump - D1 engine	DE1145	DE10254	DE10254
8029470	2	GASKET: Elbow to pressure pump - D1 engine	DE1152	DE10255	DE10255
8074661	3	GASKET: Lube oil pipe to strainer	DE1395	DE10213	DE10213
8080850	1	GASKET: Strainer housing to accessory drive cover	DE1414	DE10219	DE10219
8085182	2	SEAL: Pressure and piston cooling strainer	DE1494	DE1494	DE10912
8085253	1	GASKET: Strainer cover	DE1495	DE10328	DE10328
8360530	1	GASKET: Piston cooling inlet and outlet elbow	DE10263	DE10263	DE10263
8430019	1	GASKET: Scavenging pump inlet	DE10364	DE10847	DE10847
8478924	1	SEAL: Scavenging strainer	DE10016	DE10016	DE10957
9314918	1	GASKET: Valve seat to bottom of strainer	DE1442	DE11013	DE11013
9315446	1	SEAL: O-ring - Strainer	DE11597	DE11599	DE11599
9570678	1	GASKET: Pump inlet to pipe - Replaces 8366785	DE1059	DE10208	DE10208
9570750	1	GASKET: Valve body	DE1951	DE10331	DE10331
40024940	1	GASKET: Scavenging strainer - Replaces 9570687	DE1415	DE10326	DE10326

<b>9575132</b>	<b>1</b>	<b>KIT: Gasket - Lube oil scavenging pump</b>	<b>DE11258</b>	<b>DE11259</b>	<b>DE11259</b>
8028264	1	GASKET: Pump to accessory drive cover	DE1101	DE10222	DE10222
8074661	2	GASKET: Lube oil pipe to strainer	DE1395	DE10213	DE10213
8430019	2	GASKET: Scavenging pump inlet	DE10364	DE10847	DE10847

<b>9575134</b>	<b>1</b>	<b>KIT: Gasket - Water pump</b>	<b>DE13355</b>	<b>DE13356</b>	<b>DE13356</b>
8028760	1	GASKET: Flange - Inlet elbow	DE1112	DE10227	DE10227
8347416	1	GASKET: Pipe to crankcase	DE13014	DE10228	DE10228
9559169	1	GASKET: Pump outlet	DE13339	DE13340	DE13340
9570679	2	GASKET: Pump inlet to pipe - Replaces 8366787	DE2115	DE10295	DE10295

# EMD<sup>†</sup> GASKET KITS - BILL OF MATERIALS

OEM #	Qty	Description	Standard	Swellex + Standard	Swellex + HP
<b>9575135</b>	<b>1</b>	<b>KIT: Gasket - Turbocharger change out</b>	<b>DE11299</b>	<b>DE14661</b>	<b>DE11294</b>
8028760	1	GASKET: Flange - Inlet elbow	DE1112	DE10227	DE10227
8261200	1	GASKET: Auxiliary generator drive to turbocharger	DE1935	DE10212	DE10212
8261282	1	GASKET: Outer stubshaft cover	DE13751	DE10284	DE10284
8294874	1	SEAL: Outer stubshaft	DE1888	DE1888	DE1496
9532759	2	GASKET: Air duct to turbocharger	DE11293	DE11293	DE11293
9570602	2	GASKET: Aftercooler air duct - Replaces 8403484	DE2143	DE10286	DE10286
9570641	1	GASKET: Turbocharger mounting - Replaces 9570641	DE1704	DE10283	DE10283
9570695	1	GASKET: Aftercooler pipe to engine water outlet - Replaces 8070513	DE1381	DE10211	DE10211
9570751	2	GASKET: Elbow to ejector tube - Replaces 8271729	DE1961	DE10206	DE10206
9570757	6	GASKET: Inlet pipe to aftercooler and engine outlet "Y" - Replaces 8289171	DE10210	DE10210	DE10210
9571670	2	GASKET: Air duct to crankcase	DE2152	DE10285	DE10285
9572292	1	GASKET: Turbocharger to exhaust manifold expansion joint	DE1996	DE1996	DE1996
40010838	2	GASKET: Aftercooler inlet pipe to water manifold	DE2075	DE10209	DE10209

<b>9580694</b>	<b>1</b>	<b>KIT: Engine blower - Replaces 8209988</b>	<b>DE1772</b>	<b>DE10637</b>	<b>DE10637</b>
8024287	1	GASKET: Air filter adapter to blower housing	DE1073	DE10421	DE10421
8028465	1	GASKET: Blower to blower support	DE1105	DE10250	DE10250
8048058	1	GASKET: Oil line to drive housing flange	DE1262	DE10472	DE10472
8070199	2	GASKET: Oil separator pipe to blower adapter	DE1375	DE10514	DE10514
9570699	1	GASKET: Blower to blower drive housing cover - Replaces 8028148	DE1091	DE10251	DE10251
9570733	2	GASKET: Blower housing to oil drain line flange - Replaces 8029159	DE1137	DE10257	DE10257
9570841	2	GASKET: Oil line flange to blower housing - Replaces 8029153	DE1132	DE10256	DE10256
9571659	2	GASKET: Oil separator pipe to blower adapter - Replaces 8084407	DE1481	DE10547	DE10547

<b>9580696</b>	<b>1</b>	<b>KIT: Piston Cooling and Pressure Pump - Replaces 8210023</b>	<b>DE1804</b>	<b>DE10653</b>	<b>DE11003</b>
8028264	1	GASKET: Pump to accessory drive cover	DE1101	DE10222	DE10222
8029150	2	GASKET: Main bearing pressure portion inlet and outlet to elbow	DE1126	DE10296	DE10296
8029151	2	GASKET: Piston cooling pressure portion inlet and outlet to elbow	DE1131	DE10436	DE10436
8074661	1	GASKET: Strainer to pump elbow	DE1395	DE10213	DE10213
8082586	1	SEAL: Piston cooling pressure portion elbow to accessory drive cover	DE1529	DE1529	DE10187
8082587	1	SEAL: Main bearing pressure portion elbow to accessory drive cover	DE1443	DE1443	DE10189
8082964	1	GASKET: Piston cooling pressure portion elbow to accessory drive cover	DE1445	DE10244	DE10244
8082965	1	GASKET: Main bearing pressure portion elbow to accessory drive cover	DE1451	DE10220	DE10220
9570732	3	GASKET: Governor drive oil line - Replaces 8029154	DE1133	DE10221	DE10221

<sup>†</sup> Used for reference only



# EMD<sup>†</sup> GASKET KITS - BILL OF MATERIALS

OEM #	Qty	Description	Standard	Swellex + Standard	Swellex + HP
-------	-----	-------------	----------	--------------------	--------------

<b>9580697</b>	<b>1</b>	<b>KIT: Fuel oil manifold - Replaces 8210660</b>	<b>DE1814</b>	<b>DE10271</b>	<b>DE10271</b>
8104276	2	GASKET: Flange to filter	DE1571	DE10233	DE10233
8104292	1	GASKET: Inlet line to filter	DE1572	DE10234	DE10234
8104300	2	GASKET: Connection block	DE1573	DE10232	DE10232
8165276	2	GASKET: Supply line to manifold line	DE1684	DE10230	DE10230
9570739	2	GASKET: Supply line to manifold line - Replaces 8160114	DE1682	DE10231	DE10231

<b>9580698</b>	<b>1</b>	<b>KIT: Camshaft Drive Housing</b>	<b>DE1815</b>	<b>DE10659</b>	<b>DE10659</b>
9570576	2	GASKET: Blower support to crankcase - Replaces 8095027	DE1533	DE10249	DE10249
9570635	1	GASKET: Camshaft drive housing to crankcase - Replaces 8081380	DE1430	DE10237	DE10237
9570643	1	GASKET: Cover to housing - Upper - Replaces 8185923	DE1705	DE10247	DE10247
9570645	1	GASKET: Oil retainer - Replaces 8175858	DE1695	DE10218	DE10218

<b>9580699</b>	<b>1</b>	<b>KIT: Camshaft Drive Housing</b>	<b>DE10038</b>	<b>DE10660</b>	<b>DE10660</b>
9570576	2	GASKET: Blower support to crankcase - Replaces 8095027	DE1533	DE10249	DE10249
9570635	1	GASKET: Camshaft drive housing to crankcase - Replaces 8081380	DE1430	DE10237	DE10237
9570641	1	GASKET: Turbocharger mounting - Replaces 9570641	DE1704	DE10283	DE10283
9570645	1	GASKET: Oil retainer - Replaces 8175858	DE1695	DE10218	DE10218

<b>9580704</b>	<b>1</b>	<b>KIT: Overspeed trip housing - with bottom oil drains - Replaces 8242502</b>	<b>DE1257</b>	<b>DE10999</b>	<b>DE10999</b>
8028754	1	SEAL: Oil lockshaft	DE1359	DE1359	DE1359
8028765	2	GASKET: Plate to cover	DE1121	DE10291	DE10291
8028766	1	GASKET: Fuel lockshaft plate	DE1122	DE10292	DE10292
8104276	2	GASKET: Jumper line	DE1571	DE10233	DE10233
8104300	2	GASKET: Jumper line	DE1573	DE10232	DE10232
8143446	2	SEAL: O-ring - Retainer sleeve - Bottom groove	DE1644	DE1970	DE1970
8235618	1	GASKET: Cover to overspeed trip housing	DE11568	DE11572	DE11572
9095686	2	SEAL: O-ring - Retainer sleeve - Viton - Top groove	DE1970	DE1970	DE1970
9570589	2	GASKET: Overspeedtrip housing to crankcase - 8-645E engine only - Replaces 8235617	DE11569	DE11573	DE11573
9570688	2	GASKET: Overspeedtrip housing to crankcase - Except 8-645E engine - Replaces 8044742	DE1253	DE10259	DE10259
9570739	2	GASKET: Fuel lines to manifold blocks - Formerly 8218476 - Replaces 8160114	DE1682	DE10231	DE10231
9571656	2	GASKET: Cover - Tachometer opening - Replaces 8058257	DE1321	DE10293	DE10293

# EMD<sup>†</sup> GASKET KITS - BILL OF MATERIALS

OEM #	Qty	Description	Standard	Swellex + Standard	Swellex + HP
<b>9580705</b>	<b>1</b>	<b>KIT: Accessory drive housing - Replaces 8254494</b>	<b>DE1905</b>	<b>DE10715</b>	<b>DE11005</b>
8028760	1	GASKET: Blind cover - Water pump opening - 8 cylinder	DE1112	DE10227	DE10227
8028763	1	GASKET: Auxiliary drive cover	DE1115	DE10289	DE10289
8029165	2	GASKET: Oil stubshaft to manifold	DE1143	DE10224	DE10224
8055158	1	SEAL: Oil	DE1304	DE1304	DE1304
8069445	1	GASKET: Oil pressure valve to manifold	DE1371	DE10225	DE10225
8082586	1	SEAL: Elbow to accessory drive cover	DE1529	DE1529	DE10187
8082587	1	SEAL: Elbow to accessory drive cover	DE1443	DE1443	DE10189
8084685	1	GASKET: Cover - Lube oil relief valve	DE1484	DE10236	DE10236
8167060	1	GASKET: Manifold to crankcase - Lube oil	DE1692	DE10223	DE10223
9570623	1	GASKET: Accessory drive housing to crankcase - Replaces 8084665	DE1482	DE10214	DE10214
9570734	3	GASKET: Water line crossover - 8 cylinder - Replaces 8029163	DE1142	DE10441	DE10441
9570735	2	GASKET: Flange to drain pipe - Replaces 8029469	DE1151	DE10288	DE10288
<b>9580706</b>	<b>1</b>	<b>KIT: Overspeed Trip Housing with Bottom Oil Drains</b>	<b>DE1913</b>	<b>DE10341</b>	<b>DE10993</b>
8028754	1	SEAL: Oil lockshaft	DE1359	DE1359	DE1359
8028765	2	GASKET: Plate to cover	DE1121	DE10291	DE10291
8028766	1	GASKET: Lockshaft plate	DE1122	DE10292	DE10292
8044723	2	GASKET: Overspeed trip housing to accessory drive cover	DE1252	DE10333	DE10333
8049496	1	GASKET: Cover to overspeed trip housing	DE1282	DE10329	DE10329
8104276	2	GASKET: Jumper line	DE1571	DE10233	DE10233
8104300	2	GASKET: Jumper line	DE1573	DE10232	DE10232
8143446	2	SEAL: O-ring - Retainer sleeve - Bottom groove	DE1644	DE1644	DE1970
8218476	2	GASKET: Fuel lines to manifold blocks	DE1832	DE10332	DE10332
9095686	2	SEAL: O-ring - Retainer sleeve - Viton - Top groove	DE1970	DE1970	DE1970
9570688	2	GASKET: Overspeed trip housing to crankcase - Replaces 8044742	DE1253	DE10259	DE10259
9570739	2	GASKET: Fuel lines to manifold blocks - Formerly 8218476 - Replaces 8160114	DE1682	DE10231	DE10231
9571656	2	GASKET: Cover - Tachometer opening - Replaces 8058257	DE1321	DE10293	DE10293
<b>9580708</b>	<b>1</b>	<b>KIT: Piston Cooling and Pressure Pump - Replaces 8261167 and 8261166</b>	<b>DE1922</b>	<b>DE10723</b>	<b>DE11002</b>
8028264	1	GASKET: Pump to accessory drive cover	DE1101	DE10222	DE10222
8029467	2	GASKET: Main bearing pressure portion inlet and outlet to elbow	DE1145	DE10254	DE10254
8029470	2	GASKET: Piston cooling pressure portion inlet and outlet to elbow	DE1152	DE10255	DE10255
8029482	2	GASKET: Piston cooling pressure portion inlet and outlet to elbow	DE1154	DE10443	DE10443
8074661	1	GASKET: Strainer to Pump elbow	DE1395	DE10213	DE10213
8082586	1	SEAL: Piston cooling pressure portion elbow to accessory drive cover	DE1529	DE1529	DE10187
8082587	1	SEAL: Main bearing pressure portion elbow to accessory drive cover	DE1443	DE1443	DE10189
8082964	1	GASKET: Piston cooling pressure portion elbow to accessory drive cover	DE1445	DE10244	DE10244
8082965	1	GASKET: Main bearing pressure portion elbow to accessory drive cover	DE1451	DE10220	DE10220
9570732	3	GASKET: Governor drive oil line - Replaces 8029154	DE1133	DE10221	DE10221

<sup>†</sup> Used for reference only

# EMD<sup>†</sup> GASKET KITS - BILL OF MATERIALS

OEM #	Qty	Description	Standard	Swellex + Standard	Swellex + HP
-------	-----	-------------	----------	--------------------	--------------

<b>9580709</b>	<b>1</b>	<b>KIT: Lube oil separator - Replaces 8261172</b>	<b>DE1933</b>	<b>DE10729</b>	<b>DE10729</b>
8084670	1	GASKET: Oil separator mounting	DE1483	DE10258	DE10258
8173851	1	GASKET: Housing cover	DE1693	DE10611	DE10611
9571659	4	GASKET: Outlet pipe flange to oil separator and blower adapter - Replaces 8084407	DE1481	DE10547	DE10547

<b>9580710</b>	<b>1</b>	<b>KIT: Accessory drive housing - Replaces 8261173</b>	<b>DE1934</b>	<b>DE10272</b>	<b>DE10994</b>
8028763	1	GASKET: Auxiliary drive cover	DE1115	DE10289	DE10289
8029165	2	GASKET: Oil stubshaft to manifold	DE1143	DE10224	DE10224
8055158	1	SEAL: Oil	DE1304	DE1304	DE1304
8069445	1	GASKET: Oil pressure valve to manifold	DE1371	DE10225	DE10225
8082586	1	SEAL: Elbow to accessory drive cover	DE1529	DE1529	DE10187
8082587	1	SEAL: Elbow to accessory drive cover	DE1443	DE1443	DE10189
8084685	1	GASKET: Cover - Lube oil relief valve	DE1484	DE10236	DE10236
8167060	1	GASKET: Manifold to crankcase - Lube oil	DE1692	DE10223	DE10223
9570623	1	GASKET: Accessory drive housing to crankcase - Replaces 8084665	DE1482	DE10214	DE10214
9570735	2	GASKET: Flange to drain pipe - Replaces 8029469	DE1151	DE10288	DE10288

<b>9580711</b>	<b>1</b>	<b>KIT: Cylinder head cover and support frame - Replaces 8271649</b>	<b>DE1955</b>	<b>DE1146</b>	<b>DE1146</b>
8271623	4	GASKET: Cylinder head cover	DE1953	DE1953	DE1953
8275289	2	GASKET: Camshaft drive end	DE1966	DE10747	DE10747
9570609	2	GASKET: Frame to crankcase - Outside - Replaces 8275294 and 8470797	DE1973	DE10215	DE10215
9570610	2	GASKET: Frame to crankcase - Inside - Replaces 8275292 and 8470798	DE1972	DE10145	DE10145

<b>9580712</b>	<b>1</b>	<b>KIT: Cylinder head cover and support frame - Replaces 8271650</b>	<b>DE10866</b>	<b>DE11001</b>	<b>DE11001</b>
8271623	2	GASKET: Cylinder head cover	DE1953	DE1953	DE1953
8275289	2	GASKET: Camshaft drive end	DE1966	DE10747	DE10747
9570606	2	GASKET: Frame to crankcase - Outside - Replaces 8275291 and 8470793	DE1287	DE10814	DE10814
9570607	2	GASKET: Frame to crankcase - Inside - Replaces 8275295 and 8470794	DE1576	DE1157	DE1157

<b>9580713</b>	<b>1</b>	<b>KIT: Cylinder head cover and support frame - Replaces 8271651</b>	<b>DE10050</b>	<b>DE11000</b>	<b>DE11000</b>
8271624	4	GASKET: Cylinder head cover	DE1954	DE1954	DE1954
8275289	2	GASKET: Camshaft drive end	DE1966	DE10747	DE10747
9570608	2	GASKET: Frame to crankcase - Outside - Replaces 8275296 and 8470795	DE1974	DE10816	DE10816
9570843	2	GASKET: Frame to crankcase - Inside - Replaces 8275290 and 8470796	DE1971	DE10913	DE10913

# EMD<sup>†</sup> GASKET KITS - BILL OF MATERIALS

OEM #	Qty	Description	Standard	Swellex + Standard	Swellex + HP
<b>9580714</b>	<b>1</b>	<b>KIT: Water pump - Replaces 8276312</b>	<b>DE1982</b>	<b>DE10749</b>	<b>DE10749</b>
8028760	1	GASKET: Pump to accessory drive housing cover	DE1112	DE10227	DE10227
8231838	2	GASKET: Pipe flange to crankcase	DE1845	DE10689	DE10689
9570679	2	GASKET: Pump inlet to pipe - Replaces 8366787	DE2115	DE10295	DE10295
9570731	1	GASKET: Pump outlet to Pipe - Replaces 8029149	DE1125	DE10435	DE10435
9570734	1	GASKET: Elbow to intermediate pipe; 6-8 cylinder engines only - Replaces 8029163	DE1142	DE10441	DE10441

<b>9580715</b>	<b>1</b>	<b>KIT: Piston Cooling and Pressure Pump - Replaces 8306356</b>	<b>DE2044</b>	<b>DE10337</b>	<b>DE10932</b>
8028264	1	GASKET: Pump mounting	DE1101	DE10222	DE10222
8029150	2	GASKET: Piston cooling inlet and outlet elbow	DE1126	DE10296	DE10296
8074661	1	GASKET: Strainer to main bearing pump elbow	DE1395	DE10213	DE10213
8082586	1	SEAL: Piston cooling elbow to accessory drive housing	DE1529	DE1529	DE10187
8082587	1	SEAL: Elbow to accessory drive housing - Main bearing portion	DE1443	DE1443	DE10189
8082964	1	GASKET: Elbow to accessory drive cover - Piston cooling portion	DE1445	DE10244	DE10244
8082965	1	GASKET: Elbow to accessory drive housing - Main bearing portion	DE1451	DE10220	DE10220
8251950	2	GASKET: Elbow to pump - Main bearing portion	DE1902	DE10238	DE10238
9570732	2	GASKET: Governor drive oil line - Replaces 8029154	DE1133	DE10221	DE10221

<b>9580717</b>	<b>1</b>	<b>KIT: Lube oil separator - Replaces 8306360</b>	<b>DE2052</b>	<b>DE10342</b>	<b>DE10342</b>
8028760	1	GASKET: Flange - Inlet elbow	DE1112	DE10227	DE10227
8262488	1	GASKET: Drain tube flange	DE1944	DE10335	DE10335
8284874	1	SLEEVE: Rubber seal	DE10861	DE10861	DE10861
8285733	1	SEAL: Ring assembly	DE10860	DE10860	DE10860
8306958	2	GASKET: Elbow to oil separator	DE2053	DE10346	DE10346
9570751	2	GASKET: Elbow to ejector tube - Replaces 8271729	DE1961	DE10206	DE10206

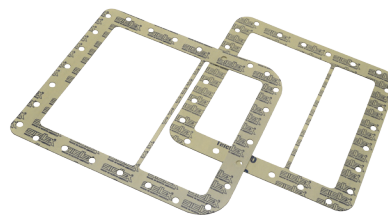

<sup>†</sup> Used for reference only

# EMD<sup>†</sup> GASKET KITS - BILL OF MATERIALS

OEM #	Qty	Description	Standard	Swellex + Standard	Swellex + HP
<b>9580719</b>	<b>1</b>	<b>KIT: Turbocharger changeout - Replaces 8328308</b>	<b>DE2062</b>	<b>DE10780</b>	<b>DE10933</b>
8028760	1	GASKET: Oil separator flange to engine	DE1112	DE10227	DE10227
8261200	1	GASKET: Auxiliary generator drive to turbocharger	DE1935	DE10212	DE10212
8261282	1	GASKET: Outer stubshaft cover	DE1943	DE10284	DE10284
8262488	1	GASKET: Oil separator drain tube	DE1944	DE10335	DE10335
8262705	2	GASKET: Aftercooler pipes to aftercooler - Large	DE1945	DE10734	DE10734
8262821	6	GASKET: Aftercooler pipes to aftercooler - Small	DE1947	DE10735	DE10735
8280352	1	SEAL: Inner stubshaft	DE1317	DE1317	DE1497
8294874	1	SEAL: Outer stubshaft	DE1888	DE1888	DE1496
8309212	1	GASKET: Exhaust manifold expansion joint to turbocharger	DE1996	DE1996	DE1996
8326114	2	GASKET: Aftercooler supply pipe flange	DE2061	DE10779	DE10779
8460205	2	GASKET: Air duct to scrool - Replaces 8261264	DE2162	DE2162	DE2162
9570596	2	GASKET: Aftercooler mounting to air duct - Replaces 8357298	DE2097	DE10793	DE10793
9570695	1	GASKET: Aftercooler pipe to engine water outlet - Replaces 8070513	DE1381	DE10211	DE10211
9570751	1	GASKET: Oil separator to turbocharger - Replaces 8271729	DE1961	DE10206	DE10206
9570757	6	GASKET: Inlet pipe to aftercooler and engine outlet "Y" - Replaces 8289171	DE2002	DE10210	DE10210
9570827	1	GASKET: Turbocharger to camshaft drive housing - Replaces 8185583 and 8451659	DE1704	DE10283	DE10283
9571669	2	GASKET: Air duct to crankcase - Replaces 8416803	DE2151	DE10805	DE10805

<b>9580720</b>	<b>1</b>	<b>KIT: Turbocharger changeout - Replaces 8328309</b>	<b>DE1557</b>	<b>DE10781</b>	<b>DE11006</b>
8028760	1	GASKET: Oil separator flange to engine	DE1112	DE10227	DE10227
8261200	1	GASKET: Auxiliary generator drive to turbocharger	DE1935	DE10212	DE10212
8261282	1	GASKET: Outer stubshaft cover	DE1943	DE10284	DE10284
8262488	1	GASKET: Oil separator drain tube flange to engine	DE1944	DE10335	DE10335
8280352	1	SEAL: Inner stubshaft	DE1317	DE1317	DE1497
8294874	1	SEAL: Outer stubshaft	DE1888	DE1888	DE1496
8309212	1	GASKET: Exhaust manifold expansion joint to turbocharger	DE1996	DE1996	DE1996
8460205	2	GASKET: Air duct to scroll - Replaces 8261264	DE2162	DE2162	DE2162
9570751	1	GASKET: Oil separator to turbocharger - Replaces 8271729	DE1961	DE10206	DE10206
9570827	1	GASKET: Turbocharger to camshaft drive housing - Replaces 8185583 and 8451659	DE1704	DE10283	DE10283
9571669	2	GASKET: Air duct to crankcase - Replaces 8416803	DE2151	DE10805	DE10805

<b>9580721</b>	<b>1</b>	<b>KIT: Governor drive - Replaces 8336989</b>	<b>DE1956</b>	<b>DE10273</b>	<b>DE10273</b>
8028209	1	GASKET: Governor drive housing cover plate	DE1092	DE10287	DE10287
8028229	1	GASKET: Governor drive mounting	DE1093	DE10200	DE10200
8028239	1	GASKET: Governor to governor drive	DE1094	DE10201	DE10201
9570732	3	GASKET: Oil line fitting - Replaces 8029154	DE1133	DE10221	DE10221

# EMD<sup>†</sup> GASKET KITS - BILL OF MATERIALS

OEM #	Qty	Description	Standard	Swellex + Standard	Swellex + HP
-------	-----	-------------	----------	--------------------	--------------

<b>9580722</b>	<b>1</b>	<b>KIT: Aftercooler changeout - Replaces 8365646</b>	<b>DE2107</b>	<b>DE10274</b>	<b>DE10274</b>
9570602	3	GASKET: Aftercooler air duct - Replaces 8403484	DE2002	DE10210	DE10210
9570757	1	GASKET: Inlet pipes to aftercooler and engine "Y"- Replaces 8289171	DE2143	DE10286	DE10286
9570762	1	GASKET: Inlet pipe to crankcase - Replaces 8347396	DE2075	DE10209	DE10209

<b>9580723</b>	<b>1</b>	<b>KIT: Water pump - Replaces 8365648</b>	<b>DE2108</b>	<b>DE10270</b>	<b>DE10270</b>
8028760	1	GASKET: Pump to accessory drive housing cover	DE1112	DE10227	DE10227
8347416	1	GASKET: Pipe to crankcase	DE2076	DE10228	DE10228
8347417	1	GASKET: Pump outlet to pipe	DE2081	DE10207	DE10207
9570678	1	GASKET: Pump inlet to pipe - Replaces 8366785	DE1059	DE10208	DE10208
9570735	1	GASKET: Water drain pipe to elbow - Replaces 8029469	DE1151	DE10288	DE10288

<b>9580724</b>	<b>1</b>	<b>KIT: Water pump - Replaces 8368757</b>	<b>DE10054</b>	<b>DE10797</b>	<b>DE10797</b>
8028760	1	GASKET: Pump to accessory drive housing cover	DE1112	DE10227	DE10227
8347416	1	GASKET: Pipe to crankcase	DE2076	DE10228	DE10228
9570679	2	GASKET: Pump inlet to pipe - Replaces 8366787	DE2115	DE10295	DE10295
9570731	1	GASKET: Pump outlet to pipe - Replaces 8029149	DE1125	DE10435	DE10435
9570734	1	GASKET: Elbow to intermediate pipe - 8 cylinder only - Replaces 8029163	DE1142	DE10441	DE10441
9570735	1	GASKET: Water drain pipe to elbow - Replaces 8029469	DE1151	DE10288	DE10288

<b>9580725</b>	<b>1</b>	<b>KIT: Camshaft Drive Housing</b>	<b>DE2122</b>	<b>DE10267</b>	<b>DE10267</b>
9570635	1	GASKET: Camshaft drive housing to crankcase - Replaces 8081380	DE1430	DE10237	DE10237
9570645	1	GASKET: Oil retainer - Replaces 8175858	DE1695	DE10218	DE10218
9570677	1	GASKET: Filter to camshaft housing - Replaces 8366424	DE2113	DE10204	DE10204
9570763	2	GASKET: Lube oil manifold to filter mounting - Replaces 8366330	DE2001	DE10290	DE10290
9570764	1	GASKET: Lube oil manifold to filter mounting - Replaces 8366331	DE1995	DE10241	DE10241

<b>9580728</b>	<b>1</b>	<b>KIT: Piston Cooling and Pressure Pump - Replaces 8375381</b>	<b>DE1759</b>	<b>DE10268</b>	<b>DE11004</b>
8028264	1	GASKET: Pump mounting	DE1101	DE10222	DE10222
8029154	2	GASKET: Governor drive oil line	DE1133	DE10221	DE10221
8074661	1	GASKET: Strainer to main bearing pump elbow	DE1395	DE10213	DE10213
8082586	1	SEAL: Piston cooling elbow to accessory drive housing	DE1529	DE10187	DE10187
8082587	1	SEAL: Elbow to accessory drive housing - Main bearing portion	DE1443	DE1443	DE10189
8082964	1	GASKET: Elbow to accessory drive cover - Piston cooling portion	DE1445	DE10244	DE10244
8082965	1	GASKET: Elbow to accessory drive housing - Main bearing portion	DE1451	DE10220	DE10220
8360530	2	GASKET: Piston cooling inlet and outlet elbow	DE2103	DE10263	DE10263

<sup>†</sup> Used for reference only

# EMD<sup>†</sup> GASKET KITS - BILL OF MATERIALS

OEM #	Qty	Description	Standard	Swellex + Standard	Swellex + HP
<b>9580730</b>	<b>1</b>	<b>KIT: Turbocharger changeout - Replaces 8380244</b>	<b>DE2131</b>	<b>DE10275</b>	<b>DE10934</b>
8028760	1	GASKET: Oil separator flange to engine	DE1112	DE10227	DE10227
8070513	1	GASKET: Aftercooler pipe to engine water outlet	DE1381	DE10211	DE10211
8261200	1	GASKET: Auxiliary generator drive to turbocharger	DE1935	DE10212	DE10212
8261282	1	GASKET: Stubshaft cover	DE1943	DE10284	DE10284
8271729	2	GASKET: Oil separator to turbocharger	DE1961	DE10206	DE10206
8289171	6	GASKET: Inlet pipe to aftercooler and engine outlet "Y"	DE2002	DE10210	DE10210
8294874	1	SEAL: Stubshaft	DE1888	DE1888	DE1496
8309212	1	GASKET: Exhaust manifold expansion joint to turbocharger	DE1996	DE1996	DE1996
8347396	2	GASKET: Aftercooler pipe to crankcase	DE2075	DE10209	DE10209
8403484	2	GASKET: Aftercooler mounting to air duct	DE2143	DE10286	DE10286
8416804	2	GASKET: Air duct to air box	DE2152	DE10285	DE10285
8451659	1	GASKET: Turbocharger to camshaft drive housing - Replaces 8185583	DE1704	DE10283	DE10283
8460205	2	GASKET: Air duct to scroll - Replaces 8261264	DE2162	DE2162	DE2162
9570762	1	GASKET: Inlet pipe to crankcase - Replaces 8347396	DE2075	DE10209	DE10209

<b>9580734</b>	<b>1</b>	<b>KIT: Turbocharger changeout - Replaces 8414907</b>	<b>DE10034</b>	<b>DE10833</b>	<b>DE11272</b>
8028760	1	GASKET: Oil separator flange to engine	DE1112	DE10227	DE10227
8070513	1	GASKET: Aftercooler pipe to engine water outlet	DE1381	DE10211	DE10211
8261200	1	GASKET: Generator and dust bin blower drive to turbocharger	DE1935	DE10212	DE10212
8261282	1	GASKET: Stubshaft cover	DE1943	DE10284	DE10284
8271729	2	GASKET: Oil separator to turbocharger	DE1961	DE10206	DE10206
8282176	2	GASKET: Pad to air duct	DE1978	DE10754	DE10754
8289171	6	GASKET: Inlet pipe to aftercooler and engine outlet "Y"	DE2002	DE10210	DE10210
8294874	1	SEAL: Stubshaft	DE1888	DE1888	DE1496
8309212	1	GASKET: Exhaust chamber expansion joint to turbocharger	DE1996	DE1996	DE1996
8347396	2	GASKET: Inlet pipe to crankcase	DE2075	DE10209	DE10209
8357298	2	GASKET: Aftercooler mounting to air duct	DE2097	DE10793	DE10793
8416803	2	GASKET: Air duct to air box	DE2151	DE10805	DE10805
8451659	1	GASKET: Turbocharger to camshaft drive housing - Replaces 8185583	DE1704	DE10283	DE10283
8460205	2	GASKET: Air duct to compressor scroll - Replaces 8261264	DE2162	DE2162	DE2162

<b>9580741</b>	<b>1</b>	<b>KIT: Lube Oil Strainer Element - Replaces 8496989</b>	<b>DE1793</b>	<b>DE10837</b>	<b>DE10995</b>
8085182	2	SEAL: Pressure and piston cooling strainer	DE1494	DE1494	DE10912
8085253	1	GASKET: Strainer cover	DE1495	DE10328	DE10328
8478924	1	SEAL: Scavenging strainer	DE10016	DE10016	DE10957
40024940	1	GASKET: Scavenging strainer - Replaces 9570687	DE1415	DE10326	DE10326

# EMD<sup>†</sup> GASKET KITS - BILL OF MATERIALS

OEM #	Qty	Description	Standard	Swellex + Standard	Swellex + HP
<b>9580742</b>	<b>1</b>	<b>KIT: Lube Oil Suction Strainer - Replaces 8496990</b>	<b>DE2046</b>	<b>DE10339</b>	<b>DE10992</b>
8029150	2	GASKET: Elbow to pressure pump - D2,D3,D3A engines	DE1126	DE10296	DE10296
8029467	4	GASKET: Pipe to scavenging pump - D1 engine	DE1145	DE10254	DE10254
8029470	2	GASKET: Elbow to pressure pump - D1 engine	DE1152	DE10255	DE10255
8074661	2	GASKET: Lube oil pipe to strainer	DE1395	DE10213	DE10213
8080850	1	GASKET: Strainer housing to accessory drive cover	DE1414	DE10219	DE10219
8080852	1	GASKET: Scavenger, oil strainer element to strainer	DE1415	DE10326	DE10326
8085182	2	SEAL: Piston cooling and main bearing strainer element	DE1494	DE1494	DE10912
8085253	1	GASKET: Strainer cover to housing	DE1495	DE10328	DE10328
8174208	1	GASKET: Drain plug	DE1138	DE10336	DE10336
8251950	1	GASKET: Pipe to piston cooling pump	DE1902	DE10238	DE10238
8251951	1	GASKET: Pipe to scavenging pump	DE1903	DE10235	DE10235
8269415	1	GASKET: Relay valve	DE1951	DE10331	DE10331
8366785	1	GASKET: Oil return elbow to strainer case - Replaces 8347468	DE1059	DE10208	DE10208
8478924	1	SEAL: Ring - Scavenging oil strainer	DE10016	DE10016	DE10957

<b>9580744</b>	<b>1</b>	<b>KIT: Cylinder head cover and support frame - Replaces 9087945</b>	<b>DE1569</b>	<b>DE1139</b>	<b>DE14593</b>
9087074	4	SEAL: Cylinder head cover	DE2170	DE2170	DE2170
9570608	2	GASKET: Frame to crankcase - Outside - Replaces 8470795	DE1974	DE10816	DE14584
9570843	2	GASKET: Frame to crankcase - Inside - Replaces 8470796	DE1971	DE10913	DE14585

<b>9580745</b>	<b>1</b>	<b>KIT: Cylinder head cover and support frame - Replaces 9087947</b>	<b>DE1567</b>	<b>DE1147</b>	<b>DE14594</b>
9087072	4	SEAL: Cylinder head cover	DE2190	DE2190	DE2190
9570631	2	GASKET: Frame to crankcase - Inside - Replaces 8470800	DE1326	DE1156	DE14583
9570634	2	GASKET: Frame to crankcase - Outside - Replaces 8470799	DE2106	DE10264	DE14582

<b>9580770</b>	<b>1</b>	<b>KIT: Overspeed Trip Housing with Rear Oil Drains</b>	<b>DE11240</b>	<b>DE11322</b>	<b>DE11322</b>
8028754	1	SEAL: Oil - Lockshaft	DE1359	DE1359	DE1359
8028765	1	GASKET: Cover plate	DE1121	DE10291	DE10291
8242408	1	SEAL: Oil - Shaft	DE10094	DE10094	DE10094
9529801	1	GASKET: Cover to housing	DE10114	DE10243	DE10243
9529807	2	SEAL: Oil - Rear drain to crankcase	DE10111	DE10998	DE10998
9570616	2	GASKET: Housing to crankcase - Replaces 9529800	DE10113	DE10242	DE10242
9570739	3	GASKET: Fuel manifold mounting - Replaces 8160114	DE1682	DE10231	DE10231
9571656	1	GASKET: Tachometer cover - Replaces 8058257	DE1321	DE10293	DE10293

<sup>†</sup> Used for reference only



# EMD<sup>†</sup> GASKET KITS - BILL OF MATERIALS

OEM #	Qty	Description	Standard	Swellex + Standard	Swellex + HP
-------	-----	-------------	----------	--------------------	--------------

<b>9583686</b>	<b>1</b>	<b>KIT: Power Assembly Installation (Old Style CTVS)</b>	<b>DE10018</b>	<b>DE10824</b>	<b>DE13863</b>
8029167	2	GASKET: Rocker arm oil line to camshaft block	DE1144	DE10217	DE10217
8142354	1	GASKET: Water inlet tube to manifold	DE1642	DE10229	DE10229
8228554	1	SEAL: Lower liner - Upper groove	DE1842	DE1842	DE1989
8305815	2	SEAL: Water outlet elbow	DE2035	DE2035	DE12034
9316850	1	SEAL: Lower liner - Lower groove	DE1989	DE1989	DE1989
9317972	2	SEAL: Water outlet elbow to crankcase	DE1316	DE1316	DE11644
9570729	1	GASKET: Inlet pipe to crankcase - Replaces 8347396	DE1084	DE10226	DE10226
9581769	1	SEAL: Cylinder Test Valve, Old Style	DE10012	DE10012	DE10012

<b>9583686</b>	<b>1</b>	<b>KIT: Power Assembly Installation (New Style CTVS)</b>	<b>DE13018</b>	<b>DE13020</b>	<b>DE13019</b>
8029167	2	GASKET: Rocker arm oil line to camshaft block	DE1144	DE10217	DE10217
8142354	1	GASKET: Water inlet tube to manifold	DE1642	DE10229	DE13903
8228554	1	SEAL: Lower liner - Upper groove	DE1842	DE1989	DE1989
8305815	2	SEAL: Water outlet elbow	DE2035	DE2035	DE12034
9316850	1	SEAL: Lower liner - Lower groove	DE1989	DE1989	DE1989
9317972	2	SEAL: Water outlet elbow to crankcase	DE1316	DE1316	DE11644
9570729	1	GASKET: Piston cooling tube to lube oil manifold	DE1084	DE10226	DE10226
40017341	1	SEAL: Cylinder Test Valve, New Style	DE11760	DE11760	DE11760

<b>40001582</b>	<b>1</b>	<b>KIT: Auxiliary generator drive - Replaces 8209989</b>	<b>DE1773</b>	<b>DE10638</b>	<b>DE10638</b>
8029153	8	GASKET: Oil line from blowers to auxiliary generator drive housing	DE1132	DE10256	DE10256
8081359	1	GASKET: Stubshaft cover	DE1424	DE10529	DE10529
8081365	1	GASKET: Cover - Rear	DE1425	DE10530	DE10530
8081398	1	GASKET: Drive to camshaft drive cover	DE1431	DE10248	DE10248
8081494	1	GASKET: Split line	DE1432	DE10531	DE10531

<b>40012903</b>	<b>1</b>	<b>KIT: Cylinder head cover and support frame - Replaces 9087946</b>	<b>DE2133</b>	<b>DE10340</b>	<b>DE14510</b>
9087073	4	SEAL: Cylinder head cover	DE2191	DE2191	DE2191
9570609	2	GASKET: Frame to crankcase - Outside - Replaces 8275294 and 8470797	DE1973	DE10215	DE14580
9570610	2	GASKET: Frame to crankcase - Inside - Replaces 8275292 and 8470798	DE1972	DE10145	DE14581

<b>40052430</b>	<b>1</b>	<b>KIT: Gasket - Lube oil separator</b>	<b>DE14059</b>	<b>DE14070</b>	<b>DE14070</b>
8028760	1	GASKET: Flange - Inlet elbow	DE1112	DE10227	DE10227
8306958	1	GASKET: Elbow to oil separator	DE2053	DE10346	DE10346
8335770	1	GASKET: Separator cover	DE1270	DE10783	DE10783
9570751	3	GASKET: Elbow to ejector tube - Replaces 8271729	DE1961	DE10206	DE10206
9574676	1	GASKET: Ejector to elbow	DE11596	DE11598	DE11598

## Contact Us Today:



[www.durox.com](http://www.durox.com)



800.238.5360



### Wabtec Elastomers Group:

- Custom Molding
- Custom Extrusion
- Mandrel Building
- Elastomer Bonding & Overmolding
- Calendering
- Die Cutting
- Orcomatic Molding



[www.wabtecelastomers.com](http://www.wabtecelastomers.com)